

ROESTVAST STAAL

Stainless steel | Edeltahl | Acier inoxydable

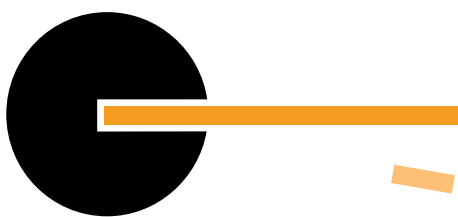

GPF
bouwbeslag

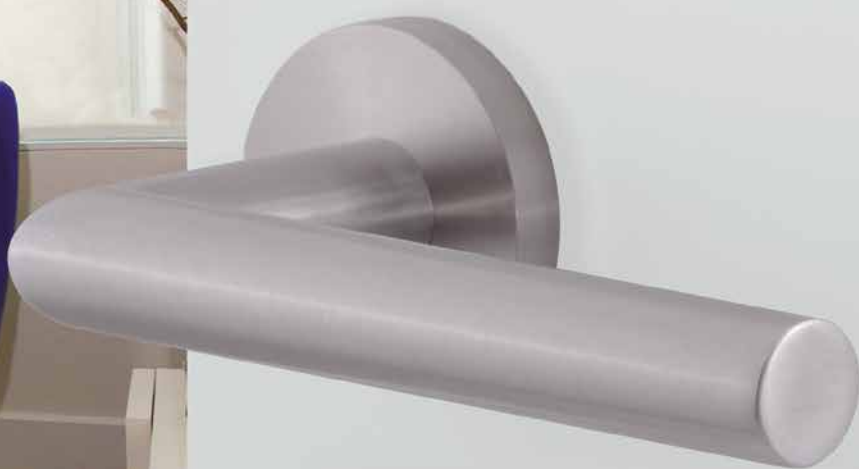

Ten Hulscher bv
DOOR & WINDOW DESIGN



CombiVari®
HET FLEXIBELE DEURBESLAG

Stel *in drie stappen* uw eigen *deurbeslag* samen

Met **GPF CombiVari** kiest u in drie stappen uw deurbeslag:

- Stap 1** Kies uw deurkruk
- Stap 2** Kies uw rozet of schild
- Stap 3** Uw keuze!

GPF deurkrukken passen op alle GPF schilden en rozetten.



Vouw de omslag open voor schilden en rozetten en maak uw keuze!

Put together your door fittings in three steps.

GPF **CombiVari** gives you the opportunity to mix and match in three steps:

- Step 1** Choose your door handle
- Step 2** Choose your rose/ plate
- Step 3** Your unique choice!

GPF door handles fits any GPF rose or plate.

Fold the cover open for roses and plates and make your choice!

In drei Schritten Ihr Türbeschlag zusammen stellen.

Mit **GPF CombiVari** wählen Sie in drei Schritten Ihre Türbeschläge:

- Schritt 1** Wählen Sie Ihren Griff
- Schritt 2** Wählen Sie Ihr Schild oder Rosette
- Schritt 3** Ihre Wahl!

GPF Türgriffe passen auf alle GPF Schilder und Rosetten.

Klappen Sie die Abdeckung für Schilder und Rosetten offen und treffen Sie Ihre Wahl!

Composez votre garniture pour porte en trois étapes.

GPF **CombiVari** vous permet de choisir votre garniture pour porte en trois étapes.

- Étape 1** : Choisissez la béquille
- Étape 2** : Choisissez la rosace ou la plaque
- Étape 3** : Votre choix!

Les béquilles GPF s'adaptent à toutes les plaques et rosaces.

Rabattez le feuillet pour les plaques et rosaces et faites votre choix !

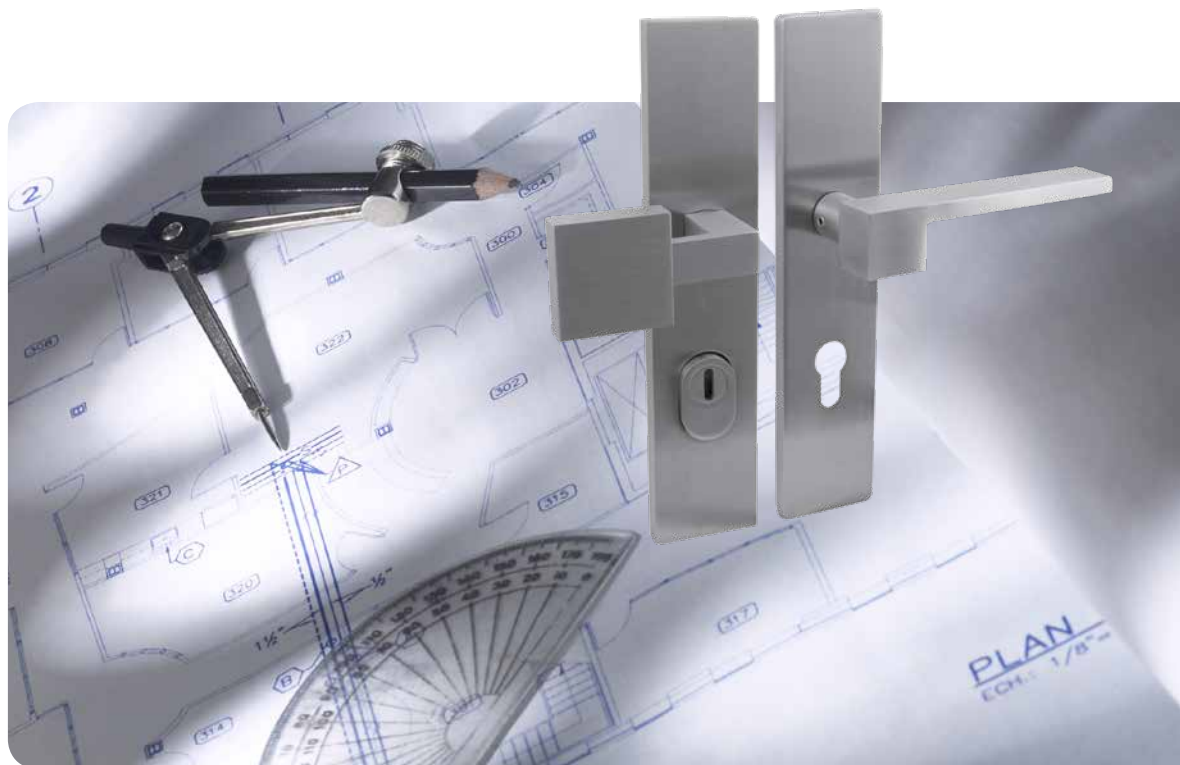

ZAKELIJK SPORTIEF

GPF roestvast staal past binnen de lifestyle Zakelijk Sportief. De moderne look wordt aangevoerd door het gebruik van roestvast staal materialen. De producten zijn naar keuze volledig door te voeren in woning- en utiliteitsbouw. Met het GPF CombiVari concept heeft u volledige keuzevrijheid in het samenstellen van deurbeslag, veiligheidsbeslag SKG*** en raambeslag. In drie stappen stelt u een unieke set samen. Ter inspiratie hebben we al diverse sets voor u samengesteld in deze brochure.



BUSINESS SPORTY

GPF stainless steel fits the lifestyle Business Sporty. The modern look is led by the use of stainless steel materials. The products fits residential and commercial constructions. GPF CombiVari gives you the opportunity to mix and match door fittings, security fittings and window fittings to reflect you individual style and choice. In three steps, you put together a unique set. For inspiration, in this brochure we already have combined several sets.

GESCHÄFTS SPORTLICH

GPF Edelstahl passt die Lebensstill Geschäfts sportlich. Der moderne Anblick wird geliefert durch die Verwendung von Edelstahl. Die Produkte sind entweder vollständig durch zu setzen nach Wahl im Wohn- und Gewerbebau. Die GPF CombiVari-Konzept haben Sie die volle Freiheit der Wahl bei der Montage von Türbeschläge, Sicherheitsschutzschilder SKG ***- und Fensterbeschläge. In drei Schritten, stellen einen einzigartigen Satz zusammen. Zur Inspiration haben wir bereits mehrere Sätze für Ihre in dieser Broschüre zusammengestellt.

SPORTIF ET RATIONNEL

Le look moderne de la gamme de produits GPF en acier inoxydable se fond parfaitement dans le style rationnel et sportif. Les produits peuvent être utilisés dans les maisons d'habitation comme dans les bâtiments industriels et publics. Le concept CombiVari de GPF permet une liberté de choix inégalable dans la composition de vos garnitures de porte, garnitures de sécurité SKG*** et ferrures pour fenêtres. Vous composez votre garniture en trois étapes. Nous vous proposons des idées et quelques compositions pour vous inspirer.

Ten Hulscher bv

 Speulderweg 38-40
3886 LB Garderen

 P.O. Box 16
3886 ZG Garderen

 +31 (0)577 46 23 07

 +31 (0)577 46 23 00

 sales@tenhulscher.com

 www.tenhulscher.com



8 DEURBESLAG
DOOR FITTINGS
TÜRBESEHLÄGE
GARNITURES DE PORTES

- 8 Deurkrukken**
Door handles
Türdrücker
Béquilles pour portes

- 24 Deurkrukken jaren 1920-1930**
Door handles 1920-1930 era
Türdrücker Jahre 1920-1930
Béquilles pour portes années 1920-1930

- 32 Raamuitzetters jaren 1920-1930**
Window expanders 1920-1930 era
Fenster Heber Jahre 1920-1930
Entrebailleurs années 1920-1930

- 34 Deurgrepen jaren 1920-1930**
Door pull handles 1920-1930 era
Türgriffe Jahre 1920-1930
Tirants pour portes années 1920-1930

- 36 Knopkrukken**
Knob handles
Knopf Drucker
Boutons béquilles

- 38 Rozetten & Accessoires**
Roses and Accessories
Rosetten und Zubehör
Rosaces et Accessoires

- 41 Schilden**
Plates
Schilder
Plaques



46 RAAMBESLAG
WINDOW FITTINGS
FENSTERBESEHLÄGE
GARNITURES DE FENÊTRES

- 46 Raamsluitingen**
Window locks
Fenster Griffe
Fermetures pour fenêtres

- 47 Draaikiepmechanismen**
Tilt and turn mechanisms
Drehkipp-Mechanismen
Mécanismes oscillo-battants

- 48 Afsluitbare draaikiepmechanismen SKG*****
Lockable tilt and turn mechanisms SKG***
Verschließbare Drehkipp-Mechanismen
Mécanismes oscillo-battants verrouillables



48 VEILIGHEIDSBESLAG SKG***
SAFETY FITTINGS SKG***
SICHERHEITSBESCHLÄGE
GARNITURES DE SÉCURITÉ

- 48 Afsluitbare draaikiepmechanismen**
Lockable tilt & turn mechanisms
Verschließbare Drehkipp-Mechanismen
Mécanismes oscillo-battants verrouillables

SCHILDEN
PLATES - SCHILDER - PLAQUES

- 50 Veiligheidsvoordeurgarnituren**
Safety entrance door fittings
Sicherheitsbeschläge
Garnitures de sécurité porte extérieur

- 54 Set Veiligheidsschilden**
Set of safety plates
Set Sicherheit Schilder
Set de plaques de sécurité

- 56 GPF CombiVari**

- 58 GPF CombiVari Veiligheidsschilden**
GPF CombiVari safety plates
GPF CombiVari Sicherheitsschilder
GPF CombiVari plaques de sécurité

- 62 GPF CombiVari veiligheidsknoppen**
GPF CombiVari safety knobs
GPF CombiVari Sicherheits Knopfen
GPF CombiVari Boutons de sécurité

ROZETTEN
ROSES - ROSETTEN - ROSACES

- 64 Set veiligheidsrozetten**
Set of safety roses
Set Sicherheit Rosetten
Set de rosaces de sécurité

- 66 GPF CombiVari veiligheidsrozetten**
GPF CombiVari safety roses
GPF CombiVari Sicherheits Rosetten
GPF CombiVari rosaces de sécurité

**Kijk voor prijzen
in de bijbehorende
prijslijst**

Look for prices in the corresponding pricelist
Achten Sie auf die Preise in der entsprechenden Preisliste
Recherchez les prix dans le tarif correspondant.



67 VOORDEURBESLAG
ENTRANCE DOOR FITTINGS
FRONTTÜRBSCHLÄGE
GARNITURE POUR PORTE D'ENTRÉE

- 67 Voordeurknoppen**
Entrance door knobs
Fronttürknöpfe
Boutons de porte extérieur
- 68 Briefplaten**
Letterplates - Briefeinwürfe -
Plaques pour boîtes aux lettres
- 68 Huisnummers**
House numbers - Hausnummern -
Lettres et numéros
- 69 Beldrukkers**
Bell pushes - Klingeltasten -
Boutons de sonnette



70 DEURGREPEN
DOOR PULL HANDLES
TÜRGRIFFE
POIGNÉES DE TIRAGE

- 70 Inleiding deurgrepen**
Introduction door pull handles
Einführung türgriffe
Introduction poignées de tirage
- 72 Deurgrepen bevestigingen**
Door pull handles fastenings
Türgriffe Befestigungen
Fixations pour poignées de tirage
- 73 Deurgrepen**
Door pull handles
Türgriffe
Poignées de tirage



80 MEUBELBESLAG
FURNITURE FITTINGS
MÖBELBSCHLÄGE
GARNITURES POUR MEUBLES

- 80 Meubelknoppen**
Furniture Knobs
Möbelknöpfe
Boutons de meuble
- 82 Meubelgrepen**
Furniture Handles
Möbelgriffe
Tirants de meuble

84 DIVERSEN
VARIOUS - DIVERSE - DIVERS

- 84 Deurstoppers**
Doorstops - Türpuffer - Arrêts de porte
- 85 Pictogrammen**
Icons
Icons
Pictogrammes
- 86 Schuifdeurkommen**
Slidings Bowls
Schiebetür Griffe
Cuvette à encastrer
- 87 Jas-/ hoedhaken**
Coat and hat hooks
Mantel- / Huthaken
Crochet porte manteaux
- 88 Overige**
Remaining - Rest - Autres



90 POST- EN SLEUTELKASTEN
POST BOXES AND KEY CABINETS
POSTKASTEN UND SCHLÜSSELSCHRÄNKE
BOITES AUX LETTRES ET ARMOIRES À CLÉS.

- 90 Postkasten**
Post boxes - Postkasten - Boîtes aux lettres
- 91 Sleutelkasten**
Key Cabinets - Schlüsselschränke -
Armoires à clés

92 EXTRA INFORMATIE
ADDITIONAL INFORMATION
WEITERE INFORMATIONEN
INFORMATIONS COMPLÉMENTAIRES

- 92 Informatie en onderhoud**
Information and maintenance
Information und Wartung
Informations et entretien
- 98 Index**

Editie: GPFVS2102

Deze brochure is met de grootste zorg samengesteld. Ondanks dit zijn wijzigingen in maat en uitvoering evenals drukfouten of kleurverschillen voorbehouden.

This brochure has been compiled with the greatest care. However, changes in sizes quoted are possible. We cannot be responsible for misprints or colour differences.

Diese Broschüre wurde mit größter Sorgfalt zusammengestellt. Trotzdem sind Änderungen in der Größe und Ausführung, sowie Druckfehler oder Farbabweichungen vorbehalten.

Cette brochure a été rédigée avec le plus grand soin – sous réserve de légères différences dans les mesures, l'aspect, la couleur ainsi que des fautes de frappe.



FLEXIBLE.
it's your choice





choose your door handle
wählen Sie Ihren Griff
choisissez la béquille

kies uw deurkruk

GPF1000 01 100 Aka
L-model ø19mm



GPF1001 01 100 Aka
L-model ø16mm



GPF1005 01 100 Hoa
U-model ø19mm



GPF1006 01 100 Hoa
U-model ø16mm



GPF1010 01 100 Kui
W-model ø19mm



GPF1015 01 100 Toi
L-haaks model ø19mm



GPF1016 01 100 Toi
L-haaks model ø16mm



GPF1020 01 100 Mai
L-ovaal model ø19mm



GPF1025 01 100 Roto



GPF1030 01 100 Puna



GPF1035 01 100 Tuna satin



GPF1037 01 100 Tuna duo



GPF1040 01 100 Kohu duo



GPF1042 01 100 Kohu satin



2 Kies uw rozet of schild

Vouw de omslag open!



Fold the cover open for roses and plates.
Falten Sie die Abdeckung offen für Rosetten und Schilder.
Rabattez le feuillet pour les rosaces et plaques.

ZAKELIJK SPORTIEF

Roestvast staal heeft iets tijdloos over zich. Een architectonische en zakelijke uitstraling door de duidelijke vlakken en lijnen. Sierlijke bijzaken worden achterwege gehouden, de aandacht ligt op sportief. In mat geborsteld of gepolijst een aangename meerwaarde voor uw interieur.

BUSINESS SPORTY

There is a timeless quality to stainless steel. The clear curves and lines compliment the appearance of any building or room in which it is used. Satin or polished finishes are available to enhance any interior.

GESCHÄFTS SPORTLICH

Edelstahl hat etwas Zeitloses über sich. Eine architektonische und sachliches Aussehen durch die Flächen und klare Linien. Anmutige Nebensächlichkeiten verzichtet, ist der Fokus auf Sportlich. Matt gebürstet oder poliert in einem erfreulichen Wert zu Ihrer Innenausstattung.

SPORTIF ET RATIONNEL

L'acier inoxydable est intemporel. Le style est architectonique et rationnel grâce aux surfaces planes et rectilignes. Il n'y a pas de place pour l'élégance ou le détail. Le look se veut sportif. En brossé mat ou poli - un 'plus' pour votre intérieur.

ROTO

GPF1025 01 100
GPF1100 00 100



Toi

GPF1015 01 100
GPF1100 00 100





Kui

GPF1010 01 100
GPF1100 10 100



Kohu DUO

GPF1040 01 100
GPF1100 40 100

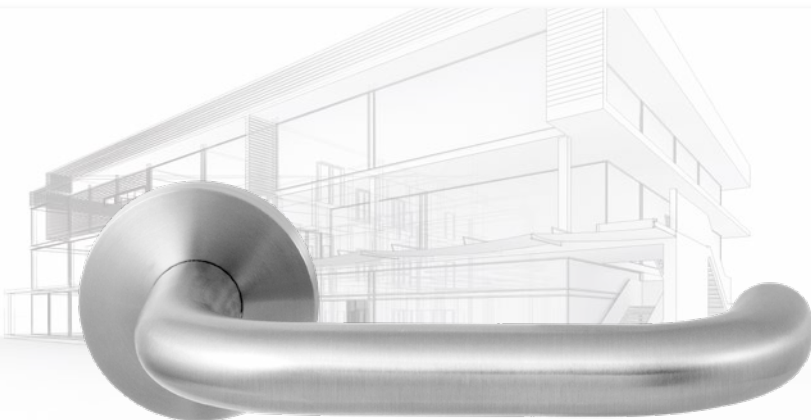

HOA

GPF1006 01 100
GPF1100 00 100



choose your door handle
wählen Sie Ihren Griff
choisissez la béquille

kies uw deurkruk

GPF1045 01 100 Rere duo



GPF1047 01 100 Rere satin



GPF1055 01 100 Haka



GPF1060 01 100 Maku



GPF1065 01 100 Muri



GPF1075 01 100 Tonga



GPF1080 01 100 Wai



GPF1085 01 100 Raki



GPF1090 01 100 Tahí



GPF1095 01 100 Motu



GPF1300 01 100 Zaki



GPF1305 01 100 Toro



GPF1310 01 100 Taka



GPF1315 01 100 Pepe



GPF1320 01 100 Ritua



MATERIAAL & FINISH

Alle deurkrukken zijn gemaakt van roestvast staal 304, meer informatie op pag. 92.

MATERIAL & FINISH

All door handles are made of stainless steel 304, more information on p. 92.

WERKSTOFF UND OBERFLÄCHE

Alle Türgriffe sind aus Edelstahl 304 gemacht, weitere Informationen ab Seite 92.

MATÉRIAU ET FINITION

Toutes nos béquilles sont en acier inoxydable 304, plus d'info à partir de la page 92.



choose your door handle
wählen Sie Ihren Griff
choisissez la béquille

kies uw deurkruk

GPF1325 01 100 Kume



GPF1330 01 100 Kare



GPF1335 01 100 Rime



GPF1340 01 100 Kino



GPF1990 01 100 Whata



GPF2025 01 100 Hoki



GPF2030 01 100 Mata



GPF2035 01 100 Papa



GPF2065 01 100 Tiki



GPF2075 01 100 Moko duo



GPF2077 01 100 Moko satin



GPF2080 01 100 Kuri duo



GPF2082 01 100 Kuri satin



M MASSIEF

Deurkrukken met dit symbool zijn van massief roestvast staal. Meer informatie vanaf pag. 93.

SOLID

Door handles with this symbol are made of solid stainless steel. More information on p. 93.

MASSIV

Türgriffe mit diesem Symbol sind aus massivem Edelstahl. Weitere Informationen ab Seite 93.

MASSIF

Les béquilles portant ce symbole sont en inox massif. Plus d'info à partir de la page 93.

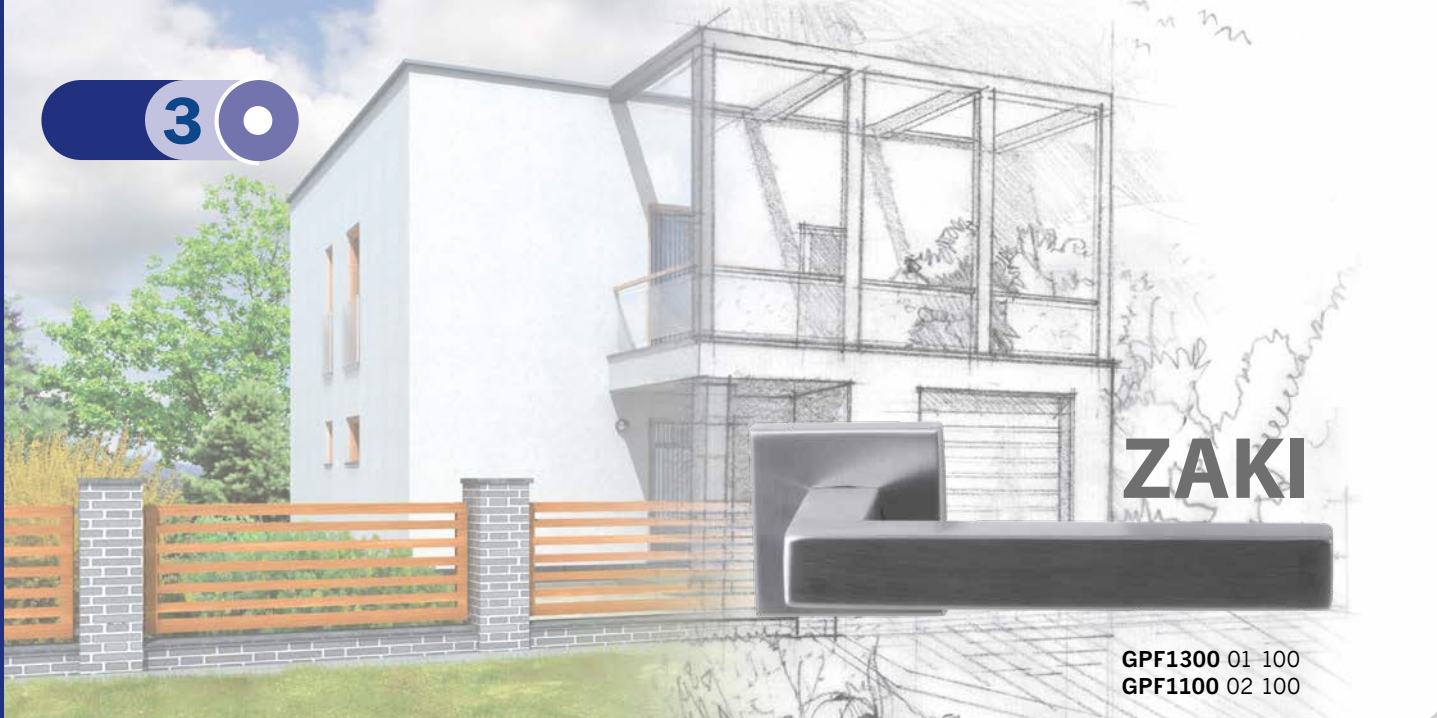
**ZAKI**

GPF1300 01 100
GPF1100 02 100

**KINO**

GPF1340 01 100
GPF1100 00 100

**Tonga**

GPF1075 01 100
GPF1100 00 100

**Kuri duo**

GPF2080 01 100
GPF1100 65 100

**Mata**

GPF2030 01 100
GPF1100 20 100

GPF Langschilden XL

Onze langschilden XL hebben een lengte van 282 mm, 62 mm langer dan de bestaande GPF langschilden. Verkrijgbaar in afgerond en rechthoekig. Alle GPF deurkrukken naar keuze passen op het schild, dankzij het GPF CombiVari concept.

282 mm

“XL

GPF Long Plates **XL**

Our long plates XL have a length of 282 mm, 62 mm longer than the normal GPF long plates. Available in rounded and rectangular. All GPF door handles fit on the plate, thanks to the GPF Combi Vari concept.

GPF Schilder **XL**

Unsere Schilder XL mit einer Länge von 282 mm, 62 mm länger als die bestehende GPF Langschilder. Erhältlich in rechteckig und abgerundet. Alle GPF Türgriffe passen auf dem Schild, durch Das GPF CombiVari Konzept.

Plaques GPF **XL**

Nos plaques XL sont plus longues de 62 mm que les plaques existantes GPF. Elle mesurent 282 mm et sont rectangulaires ou arrondies. Toutes les béquilles GPF s'adaptent à toutes les plaques grâce au concept CombiVari de GPF.

GPF1305 01 100
GPF1100 75 100



CombiVari®
HET FLEXIBELE DEURBESLAG



choose your door handle
wählen Sie Ihren Griff
choisissez la béquille

kies uw deurkruk

GPF2085 01 100 Toka



GPF2095 01 100 Knipo duo



GPF3000 01 100 Mayo duo



GPF3010 01 100 Taura duo



GPF3020 01 100 Moana duo



GPF3022 01 100 Moana satin



GPF3025 01 100 Horo duo



GPF3030 01 100 Hine duo



GPF3035 01 100 Kai satin



GPF3037 01 100 Kai duo



GPF3040 01 100 Hipi



GPF3045 01 100 Hipi



GPF3050 01 100 Hipi



GPF3085 01 100 Tino



2 Kies uw rozet of schild

Vouw de omslag open!



Fold the cover open for roses and plates.
Falten Sie die Abdeckung offen für Rosetten und Schilder.
Rabattez le feuillet pour les rosaces et plaques.



GPF3045 01 100
GPF1100 06 100

Hipi

EEN EIGENTIJDS KARAKTER

Dit populaire model jaren 1920-1930 beslag is onbeperkt te combineren en te variëren met alle GPF rozetten en schilden. Ook verkrijgbaar als raambeslag (pag. 46) en meubelbeslag (pag. 81, 83).

A CONTEMPORARY CHARACTER

This popular era (1920-1930) door handle mix and match all the GPF roses and plates. Also available as window fittings (p. 46) and furniture fittings (p. 81, 83).

UN CARACTERE CONTEMPORAIN

Ce modèle populaire des années 1920-1930 est à combiner à l'infini avec toutes les rosaces et plaques. Egalement disponible en garniture pour fenêtre (page 46) et pour mobilier (page 81, 83).

EIN ZEITGENÖSSISCHE CHARAKTER

Das beliebte Modell Jahre 1920-1930 Türbeschlag ist unbegrenzt zu kombinieren und zu variieren mit alle GPF Rosetten und Schilder. Auch als Fensterbeschläge (Seite 46) und Möbelbeschläge (Seite 81, 83).



GPF3045 01 100
GPF1100 00 100



GPF3040 01 100
GPF1100 06 100



GPF3050 01 100
GPF1100 00 100



HINE DUO

GPF3030 01 100
GPF1100 25 100



3

Deurkrukken
Door handles | Türdrücker | Béquilles pour portes



HORO DUO

GPF3025 01 100
GPF1100 40 100



TINO

GPF3085 01 100
GPF1100 20 100



Kai

GPF3035 01 100
GPF1100 00 100



choose your door handle
wählen Sie Ihren Griff
choisissez la béquille

kies uw deurkruk

GPF3100 01 100 Pirau



GPF3105 01 100 Tinga



GPF3110 01 100 Rapa



GPF3115 01 100 Hinu



GPF3120 01 100 Kore



GPF3125 01 100 Tango



GPF3130 01 100 Kanga



GPF4050 01 100 Atea





CombiVari®
HET FLEXIBELE DEURBESLAG

Ontdek de *overige finishes* op: www.tenhulscher.com

Discover the *other finishes* on:
www.tenhulscher.com

Entdecken Sie *die anderen Oberflächen*
auf: www.tenhulscher.com

Découvrez les *autres finitions* sur:
www.tenhulscher.com





*Jaren dertig
Thirties
Dreißiger Jahre
Années 30*

Nostalgie met warme houttinten

Ons jaren 1920-1930 deurbeslag is stijlvol afgewerkt met houten middenstuk in ronde vorm.
Voor buiten gebruik kiest u voor een bijpassend middenstuk van RVS of zwart gecoat.
Onmisbaar beslag voor een jaren 30 sfeer!

NOSTALGIA WITH WARM WOOD TONES

Our 1920-1930 era door hardware is stylishly decorated with a wooden centre in round shape. For outdoor use, choose a matching centerpiece stainless steel or coated black. Indispensable fittings for a 30's atmosphere!

NOSTALGIE MIT WARMEN HOLZTÖNEN

Unser Jahren 1920-1930 Türbeschlägen sind elegant mit Holzkern in runder Form gestaltet. Für den Außenbereich, wählen Sie einen passenden Kern aus Edelstahl oder schwarz beschichtet. Unverzichtbare Beschläge für eine Jahre 30-Atmosphäre!

NOSTALGIE ET TONS CHAUDS DU BOIS.

La quincaillerie années 1920-1930 avec la béquille ronde en bois est élégante. Pour usage à l'extérieur optez pour une béquille en acier inoxydable ou noir. Garnitures indispensables pour une ambiance années 30!

1920
1930



“ Ika XL *deurkrukken*

De XL deurkrukken zijn groter dan het standaard Ika model. De trend van XL deurbeslag wordt hiermee ook in de jaren 30 stijl doorgevoerd. Verkrijgbaar in diverse houtsoorten, RVS en zwart gecoat.



IKA XL DOOR HANDLES

The XL door handles are larger than the standard Ika model. The trend of XL door fittings is also reflected in the thirties style. Available in types of wood, stainless steel and coated black.

IKA XL TÜRGRIFFE

Die XL-Türgriffe sind größer als die Standard Ika-Modelle. Der Trend der XL Türbeschläge ist auch reflektiert in der dreisiger Jahren Still. Erhältlich In allen Arten von Holz, Edelstahl und schwarz beschichtet.

BÉQUILLES IKA XL

Les béquilles XL sont plus grandes que celles de standard. La tendance des béquilles XL est également présente dans le style années 30. Disponibles dans toutes les sortes de bois, en acier inoxydable et en noir.



112 mm



137 mm

XL

+ 25 mm





choose your door handle
wählen Sie Ihren Griff
choisissez la béquille

kies uw deurkruk

GPF4030 01 100 Ika
GPF4031 01 100 Ika XL



GPF4035 01 100
GPF4036 01 100 XL



GPF4040 01 100
GPF4041 01 100 XL



GPF4042 01 100
GPF4043 01 100 XL

GPF4130 01 100 Ika
GPF4131 01 100 Ika XL



GPF4135 01 100
GPF4136 01 100 XL



GPF4140 01 100
GPF4141 01 100 XL



GPF4142 01 100
GPF4143 01 100 XL

GPF4045 01 100 Ika
GPF4046 01 100 Ika XL



GPF4048 01 100
GPF4049 01 100 XL



GPF4051 01 100
GPF4052 01 100 XL

GPF4145 01 100 Ika
GPF4146 01 100 Ika XL



GPF4148 01 100
GPF4149 01 100 XL



GPF4151 01 100
GPF4152 01 100 XL

Samenstelling Ika

Welke vorm kiest u?

What shape do you choose?
Welche Form entscheiden Sie sich?
Quelle forme choisir?

Nek Neck • Hals • Col

Haaks



Right-angled
Rechtwinklich
En équerre

Gebogen



Curved
Gebogen
Courbé



GPF4230 01 100 Ika
GPF4231 01 100 Ika XL



GPF4235 01 100
GPF4236 01 100 XL

GPF4240 01 100
GPF4241 01 100 XL

GPF4242 01 100
GPF4243 01 100 XL

GPF4330 01 100 Ika
GPF4331 01 100 Ika XL



GPF4335 01 100
GPF4336 01 100 XL

GPF4340 01 100
GPF4341 01 100 XL

GPF4342 01 100
GPF4343 01 100 XL

GPF4245 01 100 Ika
GPF4246 01 100 Ika XL



GPF4248 01 100
GPF4249 01 100 XL

GPF4251 01 100
GPF4252 01 100 XL

GPF4345 01 100 Ika
GPF4346 01 100 Ika XL



GPF4348 01 100
GPF4349 01 100 XL

GPF4351 01 100
GPF4352 01 100 XL

Composition Ika • Zusammensetzung Ika • Composition Ika

Eindknop End Button • End-Taste • Embout

Verkrijgbaar Available • Erhältlich in • Disponible en

Trapezium



Trapezium
Trapez
Trapèze

Rond



Round
Um
Rond

RVS mat geborsteld

Stainless steel satin
Matt gebürstetem Edelstahl
Inox brossé mat

RVS gepolijst

Stainless steel mirror
Edelstahl poliert
Inox poli

2 Kies uw rozet of schild

Vouw de omslag open!

Fold the cover open for roses and plates.

Falten Sie die Abdeckung offen für Rosetten und Schilder.

Rabattez le feuillet pour les rosaces et plaques.

1

choose your door handle
wählen Sie Ihren Griff
choisissez la béquille

kies uw deurkruk

GPF4000 41 100 Ika
GPF4001 41 100 Ika XL



GPF4005 41 100
GPF4006 41 100 XL



GPF4010 41 100
GPF4011 41 100 XL



GPF4012 41 100
GPF4013 41 100 XL

GPF4100 41 100 Ika
GPF4101 41 100 Ika XL



GPF4105 41 100
GPF4106 41 100 XL



GPF4110 41 100
GPF4111 41 100 XL



GPF4112 41 100
GPF4113 41 100 XL

GPF4015 41 100 Ika
GPF4016 41 100 Ika XL



GPF4018 41 100
GPF4019 41 100 XL



GPF4021 41 100
GPF4022 41 100 XL

GPF4115 41 100 Ika
GPF4116 41 100 Ika XL



GPF4118 41 100
GPF4119 41 100 XL



GPF4121 41 100
GPF4122 41 100 XL

Samenstelling Ika

Welk middenstuk kiest u?

Which centerpiece do you choose?
Welchen Kern wählen Sie?
Quelle exécution choisir?

Ebben

Ebony
Ebbe
Ébène

Kersen

Cherry
Kirschen
Cerisier

Beuken

Beech
Buche
Hêtre



GPF4200 41 100 Ika
GPF4201 41 100 Ika XL



GPF4205 41 100
GPF4206 41 100 XL

GPF4210 41 100
GPF4211 41 100 XL

GPF4212 41 100
GPF4213 41 100 XL

GPF4300 41 100 Ika
GPF4301 41 100 Ika XL



GPF4305 41 100
GPF4306 41 100 XL

GPF4310 41 100
GPF4311 41 100 XL

GPF4312 41 100
GPF4313 41 100 XL

GPF4215 41 100 Ika
GPF4216 41 100 Ika XL



GPF4218 41 100
GPF4219 41 100 XL

GPF4221 41 100
GPF4222 41 100 XL

GPF4315 41 100 Ika
GPF4316 41 100 Ika XL



GPF4318 41 100
GPF4319 41 100 XL

GPF4321 41 100
GPF4322 41 100 XL

Composition Ika • Zusammensetzung Ika • Composition Ika

Eiken white wash
Oak White Wash
Oak Tünche
Chêne 'white wash'

Zwart gecoat
Coated black
Schwarz Struktur
Noir structuré

RVS mat geborsteld
Stainless steel satin
Matt gebürstetem Edelstahl
Inox brossé mat

RVS gepolijst
Stainless steel mirror
Edelstahl poliert
Inox poli

2 Kies uw rozet of schild

Vouw de omslag open!

Fold the cover open for roses and plates.
Falten Sie die Abdeckung offen für Rosetten und Schilder.
Rabattez le feuillet pour les rosaces et plaques.

Ika

Jaren 1920 - 1930

Jaren 1920-1930 deurbeslag stelt u samen met een schild of rozet naar keuze. Zo maakt u naar eigen ontwerp een moderne of een klassieke jaren 1920-1930 stijl.



IKA 1920-1930 ERA DOOR FITTINGS

1920-1930 era door fittings mix and match any GPF rose or plate. To reflect your individual modern or classic 1920-1930 style.

IKA JAHREN 1920 1930 TÜRBESCHLAG

Jahre 1920-1930 Türbeschläge mit einem Schild oder Rosette gewählt. So können Sie Ihren eigenen Entwurf machen in einen modernen oder klassischen 1920-1930 Jahre Still.

IKA GARNITURES ANNÉES 1920-1930

Combinez les garnitures années 1920-1930 avec une plaque ou une rosace au choix. De ce fait, vous créez votre propre garniture années 1920-1930 de style moderne ou plutôt classique.



GPF4015 41 100
GPF1100 65 100



GPF4030 01 100
GPF1100 09 100



GPF4115 41 100
GPF1100 46 100



GPF4100 41 100
GPF1100 43 100

..... “
Jaren 1920 - 1930 1920 - 1930 era • Jahre 1920 - 1930 • Années 1920 - 1930

Veiligheidsbeslag SKG***

De deurkruk Ika past natuurlijk ook op onze veiligheidsschilden vanaf pag 54.
Zo geniet u van de hoogste inbraakwerendheid in jaren 1920-1930 stijl.

CERTIFIED SECURITY
HARDWARE SKG***

The Ika handle also fits our certified security plates from p. 54. So you can enjoy the highest security protection in 1920-1930 style.

JAHRE 1920-1930 SCHUTZ-
BESCHLÄGE SKG***

Der Ika Griff passt natürlich auch zu unser Sicherheitsbeschläge ab Seite 54. So genießen Sie den höchsten Sicherheitsschutz gegen Einbrüche in den Jahren 1920-1930 Stil

QUINCAILLERIE DE
SÉCURITÉ

La béquille Ika convient évidemment à toutes les plaques de sécurité, voir à partir de la page 54. Vous bénéficiez du style 1920-1930 avec l'option anti-effraction.

Raambeslag

Jaren 1920 - 1930 raambeslag
op de volgende pagina.

1920-1930 era window fittings on the next page.

Jaren 1920 - 1930 Fensterbeschläge auf der nächsten Seite

Quincaillerie pour fenêtres années 1920-1930, à la page suivante.

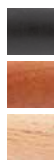

Ebben Ebony | Ebbe | Èbène

Kersen Cherry | Kirschen | Cerisier

Beuken Beech | Buche | Hêtre



Eiken white wash Oak White Wash | Oak Tünche | Chêne'white wash'

Zwart gecoat Coated black | Schwarz Struktur | Noir structuré

Jaren 1920 - 1930

Raambeslag

De Ika raamuitzetters zijn net zo stijlvol afgewerkt als de Ika deurkrukken met hout of roestvast staal naar keuze.

Met het GPF CombiVari concept zijn alle Ika deurkrukken ook toepasbaar op onze raamsluitingen en (afsluitbare) draaikiepmechanismen, vanaf pag. 46.

GPF9250 09 099
GPF4030 01 200



Ika
310 mm



GPF 4650 09 310	
GPF 4660 09 310	
GPF 4670 09 310	
GPF 4677 09 310	
GPF 4688 09 310	
GPF 4680 09 310	
GPF 4686 09 310	

Ika
320 mm



GPF 4655 09 310	
GPF 4665 09 310	
GPF 4675 09 310	
GPF 4678 09 310	
GPF 4689 09 310	
GPF 4685 09 310	
GPF 4687 09 310	



RVS Mat geborsteld Stainless steel satin | Matt gebürstetem Edelstahl
| Inox brossé mat

RVS Gepolijst Stainless steel mirror | Edelstahl poliert | Inox poli

Jaren 1920 - 1930

1920-1930 era • Jahre 1920 - 1930 • Années 1920 - 1930

WINDOW FITTINGS

The Ika casement stay and fastener are just as stylish as the Ika door handles with wood or stainless steel optional.

GPF Combi Vari gives you the opportunity to mix and match Ika door handles to our window locks and (lockable) tilt and turn mechanisms, from p. 46.

FENSTERBESCHLÄGE

Die Ika Fenster Heber sind ebenso stilvoll bearbeitet wie der Ika Türgriffe mit wahlweise Holz oder Edelstahl.

Mit GPF CombiVari Konzept sind alle Ika Türgriffe auch auf unserer Fenstersicherungen und (Verschließbaren) Drehkipp Mechanismen anwendbar, ab Seite 46.

QUINCAILLERIE POUR FENÊTRES

Les entrebailleurs pour fenêtres Ika – exécution bois ou inox au choix – sont aussi stylés que les béquilles Ika.

Le concept CombiVari permet d'assembler toutes les béquilles Ika avec nos entrebailleurs ainsi qu'avec les mécanismes oscillo-battants (verrouillables). Voir à partir de la page 46.



GPF1100 35 300
GPF4130 01 200

**VANAF
PAGINA 46**

Ika
310 mm

Gepolijst
Mirror
Poliert
Poli



GPF 4610 49 310	
GPF 4620 49 310	
GPF 4630 49 310	
GPF 4637 49 310	
GPF 4648 49 310	
GPF 4640 49 310	
GPF 4646 49 310	

Ika
320 mm

Gepolijst
Mirror
Poliert
Poli



GPF 4615 49 310	
GPF 4625 49 310	
GPF 4635 49 310	
GPF 4638 49 310	
GPF 4649 49 310	
GPF 4645 49 310	
GPF 4647 49 310	

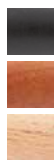

Ebben Ebony | Ebbe | Èbène

Kersen Cherry | Kirschen | Cerisier

Beuken Beech | Buche | Hêtre

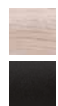

Eiken white wash Oak White Wash | Oak Tünche | Chêne'white wash'

Zwart gecoat Coated black | Schwarz Struktur | Noir structuré

Ika



		↑	⌀
GPF 4930 09 00A		130	114
GPF 4935 09 00A		130	114
GPF 4940 09 00A		130	114
GPF 4942 09 00A		130	114
GPF 4951 09 00A		130	114
GPF 4945 09 00A		130	114
GPF 4948 09 00A		130	114
GPF 4930 09 00B		157	141
GPF 4935 09 00B		157	141
GPF 4940 09 00B		157	141
GPF 4942 09 00B		157	141
GPF 4951 09 00B		157	141
GPF 4945 09 00B		157	141
GPF 4948 09 00B		157	141
GPF 4930 09 00C		207	191
GPF 4935 09 00C		207	191
GPF 4940 09 00C		207	191
GPF 4942 09 00C		207	191
GPF 4951 09 00C		207	191
GPF 4945 09 00C		207	191
GPF 4948 09 00C		207	191

Ika



		↑	⌀
GPF 4931 09 00A		130	114
GPF 4936 09 00A		130	114
GPF 4941 09 00A		130	114
GPF 4943 09 00A		130	114
GPF 4952 09 00A		130	114
GPF 4946 09 00A		130	114
GPF 4949 09 00A		130	114
GPF 4931 09 00B		157	141
GPF 4936 09 00B		157	141
GPF 4941 09 00B		157	141
GPF 4943 09 00B		157	141
GPF 4952 09 00B		157	141
GPF 4946 09 00B		157	141
GPF 4949 09 00B		157	141
GPF 4931 09 00C		207	191
GPF 4936 09 00C		207	191
GPF 4941 09 00C		207	191
GPF 4943 09 00C		207	191
GPF 4952 09 00C		207	191
GPF 4946 09 00C		207	191
GPF 4949 09 00C		207	191

Samenstelling Ika

Welke rozet kiest u?



GPF1100.00
Ø50x8mm



GPF1100.05
Ø50x6mm



GPF1100.40
Ø50x8mm



GPF1100.45
Ø50x6mm

Which rose to choose?
Welche Rosette wählen Sie?
Quelle rosace choisir?



RVS Mat geborsteld Stainless steel satin | Matt gebürstetem Edelstahl
| Inox brossé mat

RVS Gepolijst Stainless steel mirror | Edelstahl poliert | Inox poli



Lengte Length | Länge | Longueur



Hart op hart Centre to Centre | Mitte zu Mitte | Entraxe

Ika

Gepolijst
Mirror
Poliert
Poli



		↕	⊗
GPF 4900 49 00A		130	114
GPF 4905 49 00A		130	114
GPF 4910 49 00A		130	114
GPF 4912 49 00A		130	114
GPF 4921 49 00A		130	114
GPF 4915 49 00A		130	114
GPF 4918 49 00A		130	114
GPF 4900 49 00B		157	141
GPF 4905 49 00B		157	141
GPF 4910 49 00B		157	141
GPF 4912 49 00B		157	141
GPF 4921 49 00B		157	141
GPF 4915 49 00B		157	141
GPF 4918 49 00B		157	141
GPF 4900 49 00C		207	191
GPF 4905 49 00C		207	191
GPF 4910 49 00C		207	191
GPF 4912 49 00C		207	191
GPF 4921 49 00C		207	191
GPF 4915 49 00C		207	191
GPF 4918 49 00C		207	191

Ika

Gepolijst
Mirror
Poliert
Poli



		↕	⊗
GPF 4901 49 00A		130	114
GPF 4906 49 00A		130	114
GPF 4911 49 00A		130	114
GPF 4913 49 00A		130	114
GPF 4922 49 00A		130	114
GPF 4916 49 00A		130	114
GPF 4919 49 00A		130	114
GPF 4901 49 00B		157	141
GPF 4906 49 00B		157	141
GPF 4911 49 00B		157	141
GPF 4913 49 00B		157	141
GPF 4922 49 00B		157	141
GPF 4916 49 00B		157	141
GPF 4919 49 00B		157	141
GPF 4901 49 00C		207	191
GPF 4906 49 00C		207	191
GPF 4911 49 00C		207	191
GPF 4913 49 00C		207	191
GPF 4922 49 00C		207	191
GPF 4916 49 00C		207	191
GPF 4919 49 00C		207	191

Composition Ika • Zusammensetzung Ika • Composition Ika



GPF1100.02
50x50x8mm



GPF1100.06
Ø50x2mm



GPF1100.08
50x50x2mm



GPF1100.09
38x38x5mm



GPF1100.42
50x50x8mm



GPF1100.46
Ø50x2mm



GPF1100.48
50x50x2mm



GPF1100.49
38x38x5mm



kies uw knopkruk

choose your knob handle
wählen Sie Ihren Knopf Drucker
quel bouton choisir

- S1** | **Knop draaibaar per paar** S1 Rotatable knob per pair | Knopf drehbar pro Paar | Bouton tournant à la paire
- S2** | **Knop vast per stuk met knopvastzetter** S2 Knob fixed with knob fastener each | Knopf fest pro Stück mit Verschluss | Bouton fixe à la pièce avec rosace de montage bouton fixe
- S3** | **Knop vast per stuk met M10 bout** S3 Knob fixed with M10 screw each | Knopf fest pro Stück mit Schraube M10 | Bouton fixe à la pièce avec boulon M10

GPF9952
Ø 52 x 16 mm



S1	S2	S3
GPF 9952 99 100	GPF 9952 99 400	GPF 9952 99 410

GPF9954
Ø 50 mm



S1	S2	S3
GPF 9954 99 100	GPF 9954 99 400	GPF 9954 99 410

GPF9865
Ø 60 x 16 mm

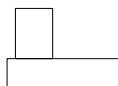

S1	S2	S3
GPF 9865 09 100	GPF 9865 09 400	GPF 9865 09 410

GPF9875
88/ Ø 55 x 24 mm



S1	S2	S3
GPF 9875 09 100	GPF 9875 09 400	GPF 9875 09 410

GPF9948
53 x 53 x 16 mm



S1	S2	S3
GPF 9948 09 100	GPF 9948 09 400	GPF 9948 09 410

GPF9950
60 x 60 x 16 mm



S1	S2	S3
GPF 9950 09 100	GPF 9950 09 400	GPF 9950 09 410

GPF3525
90/ Ø 52 x 13 mm

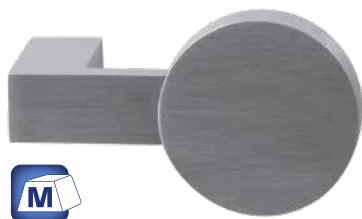

S1	S2	S3
GPF 3525 01 100	GPF 3525 01 400	GPF 3525 01 410

GPF3520
90/ 48 x 48 x 13 mm

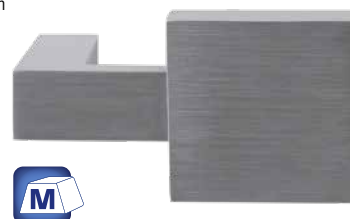

S1	S2	S3
GPF 3520 01 100	GPF 3520 01 400	GPF 3520 01 410



GPF3515
69/ Ø 52 x 13 mm

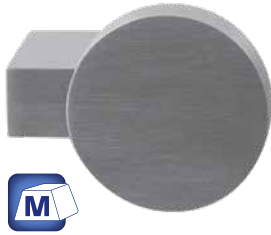

S1	S2	S3
GPF 3515 01 100	GPF 3515 01 400	GPF 3515 01 410

GPF3510
69/ 48 x 48 x 13 mm

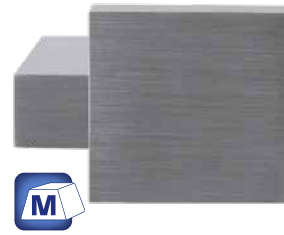

S1	S2	S3
GPF 3510 01 100	GPF 3510 01 400	GPF 3510 01 410

GPF9952
69/ Ø 52 x 13 mm

Gepolijst
Mirror
Poliert
Poli



S1	S2	S3
GPF 9952 49 100	GPF 9952 49 400	GPF 9952 49 410

GPF9954
Ø 50 mm

Gepolijst
Mirror
Poliert
Poli



S1	S2	S3
GPF 9954 49 100	GPF 9954 49 400	GPF 9954 49 410

GPF9948
53 x 53 x 16 mm

Gepolijst
Mirror
Poliert
Poli



S1	S2	S3
GPF 9948 49 100	GPF 9948 49 400	GPF 9948 49 410

GPF9950
60 x 60 x 16 mm

Gepolijst
Mirror
Poliert
Poli



S1	S2	S3
GPF 9950 49 100	GPF 9950 49 400	GPF 9950 49 410

2 Kies uw rozet of schild

Vouw de omslag open!



Fold the cover open for roses and plates.

Falten Sie die Abdeckung offen für Rosetten und Schilder.

Rabattez le feuillet pour les rosaces et plaques.



choose your rose/ plate
wählen Sie Ihr Schild oder Rosette
choisissez la rosace ou la plaque

kies uw rozet of schild



Stiftmaat Spindle size | Vierkant Stift Größe | Mesure du carré



Hart op hart Centre to Centre | Mitte zu Mitte | Entraxe

GPF1100 00 100
Ø 50 x 8 mm, ↔ 38 mm
Mat geborsteld, dubbelverend



Satin, doublespring
Matt gebürstetem, Doppelfeder
Brossé mat, à double ressort

GPF0900 00 000
Ø 50 x 8 mm



GPF0901 00 107
Ø 50 x 8 mm



GPF0902 00 108
Ø 50 x 8 mm



GPF0903 00 109
Ø 50 x 8 mm, ⊠ 8 mm



GPF0904 00 109
Ø 50 x 8 mm, ⊠ 5 mm

GPF0910 00 110
Ø 50 x 8 mm, ⊠ 8 mm



GPF0911 00 110
Ø 50 x 8 mm, ⊠ 5 mm

GPF1100 02 100
50 x 50 x 8 mm, ↔ 38 mm
Mat geborsteld, enkelverend



Satin, single spring
Matt gebürstetem, Einzelfeder
Brossé mat, à simple ressort

GPF0900 02 000
50 x 50 x 8 mm



GPF0901 02 107
50 x 50 x 8 mm



GPF0902 02 108
50 x 50 x 8 mm



GPF0903 02 109
50 x 50 x 8 mm, ⊠ 8 mm



GPF0904 02 109
50 x 50 x 8 mm, ⊠ 5 mm

GPF0910 02 110
50 x 50 x 8 mm, ⊠ 8 mm



GPF0911 02 110
50 x 50 x 8 mm, ⊠ 5 mm

GPF1100 03 100
80 x 38 x 2 mm
Mat geborsteld, zonder veer



Satin, without spring
Matt gebürstetem, ohne Feder
Brossé mat, sans ressort

GPF0901 07 107
38 x 2 mm



GPF0902 07 108
38 x 2 mm



GPF0903 07 109
38 x 2 mm, ⊠ 8 mm



GPF0904 07 109
38 x 2 mm, ⊠ 5 mm

GPF0910 07 110
38 x 2 mm, ⊠ 8 mm



GPF0911 07 110
38 x 2 mm, ⊠ 5 mm

GPF1100 04 100
65 x 30 x 10 mm
Mat geborsteld, enkelverend



Satin, single spring
Matt gebürstetem, Einzelfeder
Brossé mat, à simple ressort

GPF0902 04 108
65 x 30 x 10 mm



GPF1100 05 100
Ø 50 x 6 mm, ↔ 38 mm
Mat geborsteld, enkelverend



Satin, single spring
Matt gebürstetem, Einzelfeder
Brossé mat, à simple ressort

GPF0900 05 000
Ø 50 x 6 mm



GPF0901 05 107
Ø 50 x 6 mm



GPF0902 05 108
Ø 50 x 6 mm



GPF0903 05 109
Ø 50 x 6 mm, ⊠ 8 mm



GPF0904 05 109
Ø 50 x 6 mm, ⊠ 5 mm

GPF0910 05 110
Ø 50 x 6 mm, ⊠ 8 mm



GPF0911 05 110
Ø 50 x 6 mm, ⊠ 5 mm



GPF1100 06 100
Ø 50 x 2 mm, ↔ 38 mm

Mat geborsteld, zonder veer



Satin, without spring
Matt gebürstetem, ohne Feder
Brossé mat, sans ressort

GPF0900 06 000
Ø 50 x 2 mm

GPF0901 06 107
Ø 50 x 2 mm

GPF0902 06 108
Ø 50 x 2 mm



GPF0903 06 109
Ø 50 x 2 mm, □ 8 mm

GPF0904 06 109
Ø 50 x 2 mm, □ 5 mm

GPF0910 06 110
Ø 50 x 2 mm, □ 8 mm

GPF0911 06 110
Ø 50 x 2 mm, □ 5 mm

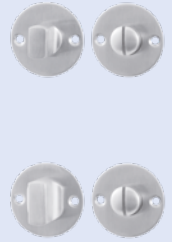

GPF1100 08 100
50 x 50 x 2 mm, ↔ 38 mm
Mat geborsteld, zonder veer



Satin, without spring
Matt gebürstetem, ohne Feder
Brossé mat, sans ressort

GPF0900 08 000
Ø 50 x 50 x 2 mm

GPF0901 08 107
Ø 50 x 50 x 2 mm

GPF0902 08 108
Ø 50 x 50 x 2 mm



GPF0903 08 109
Ø 50 x 50 x 2 mm, □ 8 mm

GPF0904 08 109
Ø 50 x 50 x 2 mm, □ 5 mm

GPF0910 08 110
Ø 50 x 50 x 2 mm, □ 8 mm

GPF0911 08 110
Ø 50 x 50 x 2 mm, □ 5 mm



GPF1100 09 100
38 x 38 x 5 mm
Mat geborsteld, zonder veer



Satin, without spring
Matt gebürstetem, ohne Feder
Brossé mat, sans ressort

GPF0901 09 107
38 x 38 x 5 mm

GPF0902 09 108
48 x 38 x 5 mm

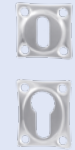

GPF0903 09 109
38 x 38 x 5 mm, □ 8 mm

GPF0904 09 109
38 x 38 x 5 mm, □ 5 mm

GPF0910 09 109
38 x 38 x 5 mm, □ 8 mm

GPF0911 09 109
38 x 38 x 5 mm, □ 5 mm



GPF1100 40 100
Ø 50 x 8 mm, ↔ 38 mm
Gepolijst, dubbelverend



Mirror, doublespring
Poliert, Doppelfeder
Poli, à double ressort

GPF0900 40 000
Ø 50 x 8 mm

GPF0901 40 107
Ø 50 x 8 mm

GPF0902 40 108
Ø 50 x 8 mm



GPF0903 40 109
Ø 50 x 8 mm, □ 8 mm

GPF0904 40 109
Ø 50 x 8 mm, □ 5 mm

GPF0910 40 110
Ø 50 x 8 mm, □ 8 mm

GPF0911 40 110
Ø 50 x 8 mm, □ 5 mm



GPF1100 42 100
50 x 50 x 8 mm, ↔ 38 mm
Gepolijst, enkelverend



Mirror, single spring
Poliert, Einzelfeder
Poli, à simple ressort

GPF0900 42 000
50 x 50 x 8 mm

GPF0901 42 107
50 x 50 x 8 mm

GPF0902 42 108
50 x 50 x 8 mm



GPF0903 42 109
50 x 50 x 8 mm, □ 8 mm

GPF0904 42 109
50 x 50 x 8 mm, □ 5 mm

GPF0910 42 110
50 x 50 x 8 mm, □ 8 mm

GPF0911 42 110
50 x 50 x 8 mm, □ 5 mm



2

choose your rose/ plate
wählen Sie Ihr Schild oder Rosette
choisissez la rosace ou la plaque

kies uw rozet of schild



Stiftmaat Spindle size | Vierkant Stift Große | Mesure du carré



Hart op hart Centre to Centre | Mitte zu Mitte | Entraxe

GPF1100 43 100
80 x 38 x 2 mm
Gepolijst, zonder veer



Mirror, without spring
Poliert, ohne Feder
Poli, sans ressort

GPF0901 47 107
38 x 2 mm



GPF0902 47 107
38 x 2 mm



GPF0903 47 109
38 x 2 mm, \square 8 mm



GPF0904 47 109
38 x 2 mm, \square 5 mm

GPF0910 47 110
38 x 2 mm, \square 8 mm



GPF0911 47 110
38 x 2 mm, \square 5 mm

GPF1100 45 100
Ø 50 x 6 mm, \leftrightarrow 38 mm
Gepolijst, enkelverend



Mirror, single spring
Poliert, Einzelfeder
Poli, à simple ressort

GPF0901 45 107
Ø 50 x 6 mm



GPF0902 45 107
Ø 50 x 6 mm



GPF0903 45 109
Ø 50 x 6 mm, \square 8 mm



GPF0904 45 109
Ø 50 x 6 mm, \square 5 mm

GPF0910 45 110
Ø 50 x 6 mm, \square 8 mm



GPF0911 45 110
Ø 50 x 6 mm, \square 5 mm

GPF1100 46 100
Ø 50 x 2 mm, \leftrightarrow 38 mm
Gepolijst, zonder veer



Mirror, without spring
Poliert, ohne Feder
Poli, sans ressort

GPF0900 46 000
Ø 50 x 2 mm



GPF0901 46 107
Ø 50 x 2 mm



GPF0902 46 107
Ø 50 x 2 mm



GPF0903 46 109
Ø 50 x 2 mm, \square 8 mm



GPF0904 46 109
Ø 50 x 2 mm, \square 5 mm

GPF0910 46 110
Ø 50 x 2 mm, \square 8 mm



GPF0911 46 110
Ø 50 x 2 mm, \square 5 mm

GPF1100 48 100
50 x 50 x 2 mm, \leftrightarrow 38 mm
Gepolijst, zonder veer



Mirror, without spring
Poliert, ohne Feder
Poli, sans ressort

GPF0900 48 000
50 x 50 x 2 mm



GPF0901 48 107
50 x 50 x 2 mm



GPF0902 48 107
50 x 50 x 2 mm



GPF0903 48 109
50 x 50 x 2 mm, \square 8 mm



GPF0904 48 109
50 x 50 x 2 mm, \square 5 mm

GPF0910 48 110
50 x 50 x 2 mm, \square 8 mm



GPF0911 48 110
50 x 50 x 2 mm, \square 5 mm

GPF1100 49 100
38 x 38 x 5 mm
Gepolijst, zonder veer



Mirror, without spring
Poliert, ohne Feder
Poli, sans ressort

GPF0901 49 107
38 x 38 x 5 mm



GPF0902 49 108
48 x 38 x 5 mm



GPF0903 49 109
38 x 38 x 5 mm, \square 8 mm



GPF0904 49 109
38 x 38 x 5 mm, \square 5 mm

GPF0910 49 109
38 x 38 x 5 mm, \square 8 mm



GPF0911 49 109
38 x 38 x 5 mm, \square 5 mm





RVS Mat geborsteld Stainless steel satin | Matt gebürstetem Edelstahl
| Inox brossé mat







RVS Gepolijst Stainless steel mirror | Edelstahl poliert | Inox poli



Toiletstift normaal

Bathroom set normal knob
WC normalen stift
Carré pour garniture toilette, bouton normal









 ↓ 20mm		
GPF 1105 09 109		5
GPF 1105 49 109		5
GPF 1108 09 109		8
GPF 1108 49 109		8

Toiletstift groot

Bathroom set large knob
WC Stift Groß
Carré pour garniture toilette, grand bouton



 ↓ 30mm		
GPF 1111 09 109		5
GPF 1111 49 109		5
GPF 1110 09 109		8
GPF 1110 49 109		8



kies uw rozet of schild

choose your rose/ plate
wählen Sie Ihr Schild oder Rosette
choisissez la rosace ou la plaque



Sleutelgat Keyhole | Schlüsselloch | Trou de serrure



Profielcilinder Profile cylinder | Profizylinder | Cylindre profilé



Vrij/ bezet Privacy bolt | WC | Rosace libre/occupé

GPF1100.10

169 x 46 x 8,5 mm

Mat geborsteld, enkelveerend | Satin, single spring |

Matt gebürstetem, Einzelfeder | Brossé mat, à simple ressort



GPF 1100 10 100	
GPF 1100 10 101	⌘ 56
GPF 1100 10 111	⌘ 72
GPF 1100 10 132	⌚ 55
GPF 1100 10 142	⌚ 72

↓ 20mm	
GPF 1100 10 884	⊖ 57/5
GPF 1100 10 885	⊖ 63/8

↓ 30mm	
GPF 1100 10 857	⊖ 57/5
GPF 1100 10 863	⊖ 63/8

GPF 1200 10 100

GPF1100.12

181 x 41 x 2 mm

Mat geborsteld, zonder veer | Satin, without spring |

Matt gebürstetem, ohne Feder | Brossé mat, sans ressort



GPF 1100 12 100	
GPF 1100 12 101	⌘ 56
GPF 1100 12 111	⌘ 72
GPF 1100 12 132	⌚ 55
GPF 1100 12 142	⌚ 72

↓ 20mm	
GPF 1100 12 884	⊖ 57/5
GPF 1100 12 885	⊖ 63/8

↓ 30mm	
GPF 1100 12 857	⊖ 57/5
GPF 1100 12 863	⊖ 63/8

GPF1100.20

218 x 40 x 8,5 mm

Mat geborsteld, enkelveerend | Satin, single spring |

Matt gebürstetem, Einzelfeder | Brossé mat, à simple ressort



GPF 1100 20 100	
GPF 1100 20 101	⌘ 56
GPF 1100 20 111	⌘ 72
GPF 1100 20 132	⌚ 55
GPF 1100 20 142	⌚ 72

↓ 20mm	
GPF 1100 20 884	⊖ 57/5
GPF 1100 20 885	⊖ 63/8

↓ 30mm	
GPF 1100 20 857	⊖ 57/5
GPF 1100 20 863	⊖ 63/8

GPF 1200 20 100

GPF1100.21

220 x 40 x 2 mm

Mat geborsteld, zonder veer | Satin, without spring |

Matt gebürstetem, ohne Feder | Brossé mat, sans ressort



GPF 1100 21 100	
GPF 1100 21 101	⌘ 56
GPF 1100 21 111	⌘ 72
GPF 1100 21 132	⌚ 55
GPF 1100 21 142	⌚ 72

↓ 20mm	
GPF 1100 21 884	⊖ 57/5
GPF 1100 21 885	⊖ 63/8

↓ 30mm	
GPF 1100 21 857	⊖ 57/5
GPF 1100 21 863	⊖ 63/8



GPF1100.22

240 x 40 x 2 mm

Mat geborsteld, zonder veer | Satin, without spring |

Matt gebürstetern, ohne Feder | Brossé mat, sans ressort



GPF 1100 22 100	
GPF 1100 22 101	⌀ 56
GPF 1100 22 111	⌀ 72
GPF 1100 22 132	⌀ 55
GPF 1100 22 142	⌀ 72

↓ 20mm	
GPF 1100 22 884	⊖ 57/5
GPF 1100 22 885	⊖ 63/8

↓ 30mm	
GPF 1100 22 857	⊖ 57/5
GPF 1100 22 863	⊖ 63/8

GPF1100.23

240 x 30 x 2 mm

Mat geborsteld, zonder veer | Satin, without spring |

Matt gebürstetern, ohne Feder | Brossé mat, sans ressort



GPF 1100 23 100	
GPF 1100 23 101	⌀ 56
GPF 1100 23 111	⌀ 72
GPF 1100 23 132	⌀ 55
GPF 1100 23 142	⌀ 72

↓ 20mm	
GPF 1100 23 884	⊖ 57/5
GPF 1100 23 885	⊖ 63/8

↓ 30mm	
GPF 1100 23 857	⊖ 57/5
GPF 1100 23 863	⊖ 63/8

GPF1100.70

282 x 40 x 8,5 mm

Mat geborsteld, enkelverend | Satin, single spring |

Matt gebürstetern, Einzelfeder | Brossé mat, à simple ressort



“XL”

GPF 1100 70 100	
GPF 1100 70 101	⌀ 56
GPF 1100 70 111	⌀ 72
GPF 1100 70 132	⌀ 55
GPF 1100 70 142	⌀ 72

↓ 20mm	
GPF 1100 70 884	⊖ 57/5
GPF 1100 70 885	⊖ 63/8

↓ 30mm	
GPF 1100 70 857	⊖ 57/5
GPF 1100 70 863	⊖ 63/8

GPF1100.60

218 x 40 x 8,5mm

Gepolijst, enkelverend | Mirror, single spring |

Poliert, Einzelfeder | Poli, à simple ressort



GPF 1100 60 100	
GPF 1100 60 101	⌀ 56
GPF 1100 60 111	⌀ 72
GPF 1100 60 132	⌀ 55
GPF 1100 60 142	⌀ 72

↓ 20mm	
GPF 1100 60 884	⊖ 57/5
GPF 1100 60 885	⊖ 63/8

↓ 30mm	
GPF 1100 60 857	⊖ 57/5
GPF 1100 60 863	⊖ 63/8

GPF 1200 60 100



choose your rose/ plate
wählen Sie Ihr Schild oder Rosette
choisissez la rosace ou la plaque

kies uw rozet of schild



Sleutelgat Keyhole | Schlüsselloch | Trou de serrure



Profielcilinder Profile cylinder | Profizylinder | Cylindre profilé



Vrij/ bezet Privacy bolt | WC | Rosace libre/occupé

GPF1100.15

169 x 46 x 8,5 mm

Mat geborsteld, enkelverend | Satin, single spring |

Matt gebürstetem, Einzelfeder | Brossé mat, à simple ressort



GPF 1100 15 100	
GPF 1100 15 101	⌘ 56
GPF 1100 15 111	⌘ 72
GPF 1100 15 132	⌚ 55
GPF 1100 15 142	⌚ 72

↓ 20mm	
GPF 1100 15 884	⊖ 57/5
GPF 1100 15 885	⊖ 63/8

↓ 30mm	
GPF 1100 15 857	⊖ 57/5
GPF 1100 15 863	⊖ 63/8

GPF 1200 15 100

GPF1100.16

181 x 41 x 2 mm

Mat geborsteld, zonder veer | Satin, without spring |

Matt gebürstetem, ohne Feder | Brossé mat, sans ressort



GPF 1100 16 100	
GPF 1100 16 101	⌘ 56
GPF 1100 16 111	⌘ 72
GPF 1100 16 132	⌚ 55
GPF 1100 16 142	⌚ 72

↓ 20mm	
GPF 1100 16 884	⊖ 57/5
GPF 1100 16 885	⊖ 63/8

↓ 30mm	
GPF 1100 16 857	⊖ 57/5
GPF 1100 16 863	⊖ 63/8

GPF1100.25

218 x 40 x 8,5 mm

Mat geborsteld, enkelverend | Satin, single spring |

Matt gebürstetem, Einzelfeder | Brossé mat, à simple ressort



GPF 1100 25 100	
GPF 1100 25 101	⌘ 56
GPF 1100 25 111	⌘ 72
GPF 1100 25 132	⌚ 55
GPF 1100 25 142	⌚ 72

↓ 20mm	
GPF 1100 25 884	⊖ 57/5
GPF 1100 25 885	⊖ 63/8

↓ 30mm	
GPF 1100 25 857	⊖ 57/5
GPF 1100 25 863	⊖ 63/8

GPF 1200 25 100

GPF1100.26

220 x 40 x 2 mm

Mat geborsteld, zonder veer | Satin, without spring |

Matt gebürstetem, ohne Feder | Brossé mat, sans ressort



GPF 1100 26 100	
GPF 1100 26 101	⌘ 56
GPF 1100 26 111	⌘ 72
GPF 1100 26 132	⌚ 55
GPF 1100 26 142	⌚ 72

↓ 20mm	
GPF 1100 26 884	⊖ 57/5
GPF 1100 26 885	⊖ 63/8

↓ 30mm	
GPF 1100 26 857	⊖ 57/5
GPF 1100 26 863	⊖ 63/8



GPF1100.27

240 x 40 x 2 mm

Mat geborsteld, zonder veer | Satin, without spring |

Matt gebürstetem, ohne Feder | Brossé mat, sans ressort



GPF 1100 27 100	
GPF 1100 27 101	⌀ 56
GPF 1100 27 111	⌀ 72
GPF 1100 27 132	⌀ 55
GPF 1100 27 142	⌀ 72

⌀ ↓ 20mm	
GPF 1100 27 884	⊖ 57/5
GPF 1100 27 885	⊖ 63/8

⌀ ↓ 30mm	
GPF 1100 27 857	⊖ 57/5
GPF 1100 27 863	⊖ 63/8

GPF1100.28

240 x 30 x 2 mm

Mat geborsteld, zonder veer | Satin, without spring |

Matt gebürstetem, ohne Feder | Brossé mat, sans ressort



GPF 1100 28 100	
GPF 1100 28 101	⌀ 56
GPF 1100 28 111	⌀ 72
GPF 1100 28 132	⌀ 55
GPF 1100 28 142	⌀ 72

⌀ ↓ 20mm	
GPF 1100 28 884	⊖ 57/5
GPF 1100 28 885	⊖ 63/8

⌀ ↓ 30mm	
GPF 1100 28 857	⊖ 57/5
GPF 1100 28 863	⊖ 63/8

GPF1100.75

282 x 40 x 8,5 mm

Mat geborsteld, enkelverend | Satin, single spring |

Matt gebürstetem, Einzelfeder | Brossé mat, à simple ressort



“XL”

GPF 1100 75 100	
GPF 1100 75 101	⌀ 56
GPF 1100 75 111	⌀ 72
GPF 1100 75 132	⌀ 55
GPF 1100 75 142	⌀ 72

⌀ ↓ 20mm	
GPF 1100 75 884	⊖ 57/5
GPF 1100 75 885	⊖ 63/8

⌀ ↓ 30mm	
GPF 1100 75 857	⊖ 57/5
GPF 1100 75 863	⊖ 63/8

GPF1100.65

218 x 40 x 8,5 mm

Gepolijst, enkelverend | Mirror, single spring |

Poliert, Einzelfeder | Poli, à simple ressort



GPF 1100 65 100	
GPF 1100 65 101	⌀ 56
GPF 1100 65 111	⌀ 72
GPF 1100 65 132	⌀ 55
GPF 1100 65 142	⌀ 72

⌀ ↓ 20mm	
GPF 1100 65 884	⊖ 57/5
GPF 1100 65 885	⊖ 63/8

⌀ ↓ 30mm	
GPF 1100 65 857	⊖ 57/5
GPF 1100 65 863	⊖ 63/8

GPF 1200 65 100

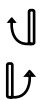

Linksdraaiend Left turning | Linksdrehend | Poussant gauche (din droite)

Rechtsdraaiend Right turning | Rechtsdrehend | Poussant droite (din gauche)



GPF1100.35
76 x 32 x 15 mm



GPF 1100 35 200



GPF 1100 35 300

GPF1100.55
76 x 32 x 15 mm



Gepolijst
Mirror
Poliert
Poli



GPF 1100 55 200



GPF 1100 55 300



GPF1100 35 300
GPF4130 01 200



GPF COMBIVARI

Mechanismen exclusief raamkruk. Combineer met al onze GPF krukken van pag. 8 - 29.

GPF COMBIVARI

Mechanisms excluding window handle. Combine with our GPF handles from pg. 8-29.

GPF COMBIVARI

Mechanismen ohne Fenster-Griff. Kombinieren Sie mit alle unseren GPF Griffe ab Seite 8-29.

GPF COMBIVARI

Mécanismes oscillo-battants pour fenêtre. A combiner avec toutes nos béquilles GPF, de la page 8 à la page 29.



GPF1100 30 100
65 x 30 x 12 mm



GPF1100 31 100
65 x 30 x 12 mm



GPF1100 53 100
65 x 30 x 12 mm

Gepolijst
Mirror
Poliert
Poli



GPF1100 54 100
65 x 30 x 12 mm

Gepolijst
Mirror
Poliert
Poli



GPF1100 30 100
GPF1001 01 200

GPF1100 53 100
GPF1040 01 200

GPF1100 31 100
GPF1300 01 200

GPF9250 09 099
83 x 34 x 31 mm



GPF9252 09 099
83 x 34 x 31 mm



GPF9250 09 099
GPF1800 01 300



GPF1800 01 200



SKG*** VEILIGHEIDSBSLAG

Met onze GPF krukken voldoet de combinatie aan de hoogste norm voor inbraakwerendheid.

SKG*** SECURITY FITTINGS

With our GPF handles the combination conforms to the highest standard for protection against burglary.

SKG*** SICHERHEITSBESCHLÄGE

Mit unserer GPF Griffe entspricht die Kombination den Bestimmungen der höchsten Standard für Einbruchhemmung.

GARNITURES SKG***

La combinaison des garnitures et des béquilles répond aux normes les plus élevées d'anti effraction.



GPF COMBIVARI

Mechanismen exclusief raamkruk. Combineer met al onze GPF krukken van pag. 8 - 29.

GPF COMBIVARI

Mechanisms excluding window handle. Combine with our GPF handles from pg. 8-29.

GPF COMBIVARI

Mechanismen ohne Fenster-Griff. Kombinieren Sie mit alle unseren GPF Griffe ab Seite 8-29.

GPF COMBIVARI

Mécanismes oscillo-battants pour fenêtre. A combiner avec toutes nos béquilles GPF, de la page 8 à la page 29.

GPF9250 49 099
83 x 34 x 31 mm

Gepolijst
Mirror
Poliert
Poli



GPF9252 49 099
83 x 34 x 31 mm

Gepolijst
Mirror
Poliert
Poli



GPF9252 49 099
GPF2080 01 200



GPF9250 09 099
GPF2035 01 300



GPF9250 09 099
GPF4030 01 200





Profielcilinder Profile cylinder | Profilylinder | Cylindre profilé



Knop vast per stuk Fixed knob each | Knopf fest pro Stück | Bouton fixe à la pièce



Deurkruk Doorhandle | Griff | Béquille



GPF9844

Buitenschild | Outside plate
Außenschild | Plaque pour l'extérieur
248 x 52 x 11 mm

Binnenschild | Inside plate
Innenschild | Plaque pour l'intérieur
248 x 52 x 8 mm

- GPF9854.09
- GPF1315



GPF 9844 09 032	🔑 55
GPF 9844 09 042	🔑 72
GPF 9844 09 052	🔑 85
GPF 9844 09 062	🔑 92

GPF9311

Buitenschild | Outside plate
Außenschild | Plaque pour l'extérieur
248 x 52 x 11 mm

Binnenschild | Inside plate
Innenschild | Plaque pour l'intérieur
248 x 52 x 8 mm

- GPF9858.09
- GPF1300

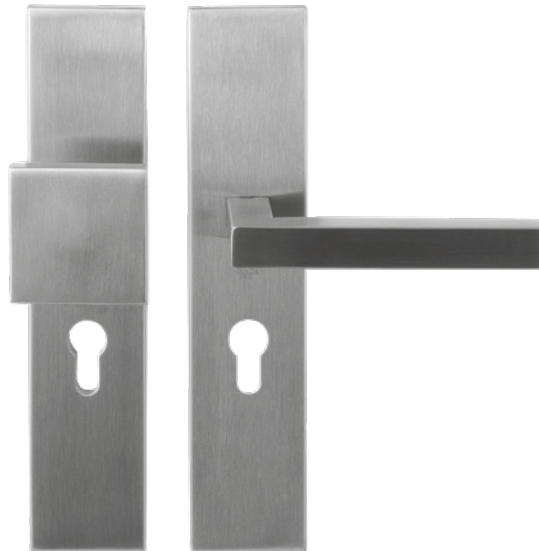

GPF 9311 09 032	🔑 55
GPF 9311 09 042	🔑 72
GPF 9311 09 052	🔑 85
GPF 9311 09 062	🔑 92

GPF veiligheidsbeslag, onderscheidend sterk!

Veiligheidsbeslag van GPF bouwbeslag voldoet aan de hoogste inbraakwerende eisen van het Nederlandse Certificering instituut SKG (Stichting Kwaliteit Gevelbouw) in samenwerking met PKVW (Politie Keurmerk Veilig Wonen) en NBR (Nationale Beveiligings Richtlijn).

Knop wordt voorgemonteerd op schild.





Linkswijzend Pointing Left | Nach Links zeigend |
Main gauche



Rechtswijzend Pointing right | Nach Rechts zeigend |
Main droite





Inclusief bevestigingsset t.b.v. deurdikte 40 en 54 mm, overige: pag. 95.
Including fastenings for door thickness 40 and 54 mm, other: p. 95.
Inklusive Befestigung für den Türstärke 40 und 54 mm, Andere: ab Seite. 95.
Set de fixations inclus pour épaisseur de porte de 40 et 54mm, voir page 95.





GPF9341

Buitenschild | Outside plate
Außenschild | Plaque pour l'extérieur
248 x 52 x 11 mm

Binnenschild | Inside plate
Innenschild | Plaque pour l'intérieur
248 x 52 x 8 mm

 GPF9870.09
 GPF1005





	GPF 9341 09 542		Q 72
	GPF 9341 09 642		Q 72





GPF9351

Buitenschild | Outside plate
Außenschild | Plaque pour l'extérieur
248 x 52 x 11 mm

Binnenschild | Inside plate
Innenschild | Plaque pour l'intérieur
248 x 52 x 8 mm

 GPF9860.09
 GPF1015



	GPF 9351 09 542		Q 72
	GPF 9351 09 642		Q 72

GPF security fittings, distinctive strong!

Security fittings from GPF architectural hardware meets the highest burglary resistant requirements of the Dutch Certification Institute SKG (Foundation for Quality Facade constructions) in collaboration with the Dutch security label PKVW and guideline foundation NBR.

Knob will be preassembled on plate

GPF Sicherheitsbeschläge, unverwechselbar stark!

Sicherheitsbeschläge, Baubeschläge GPF erfüllt die höchsten Anforderungen an Einbruchhemmung von der niederländischen Zertifizierungsinstitut SKG in Zusammenarbeit mit PKVW und NBIR.

Knopf wird auf Schild vormontiert.

Garnitures de sécurité, la solidité à toute épreuve!

Les garnitures de sécurité GPF répondent aux plus hautes exigences d'anti effraction de l'Institut Néerlandais de Certification SKG (Stichting Kwaliteit Gevelbouw) en collaboration avec le label de sécurité PKVW (Politie Keurmerk Veilig Wonen) et la directive nationale de sécurité (NBR).

Le bouton est prémonté sur la plaque.





Profielcilinder Profile cylinder | Profilzylinder | Cylindre profilé



Knop vast per stuk Fixed knob each | Knopf fest pro Stück | Bouton fixe à la pièce





Deurkruk Doorhandle | Griff | Béquille



GPF9307

Buitschild | Outside plate
Außenschild | Plaque pour l'extérieur
248 x 52 x 11 mm

Binnenschild | Inside plate
Innenschild | Plaque pour l'intérieur
248 x 52 x 8 mm

 GPF9202.09
 GPF2082





	
GPF 9307 09 532	🔑 55
GPF 9307 09 542	🔑 72
GPF 9307 09 562	🔑 92

	
GPF 9307 09 632	🔑 55
GPF 9307 09 642	🔑 72
GPF 9307 09 662	🔑 92

GPF9317

Buitschild | Outside plate
Außenschild | Plaque pour l'extérieur
248 x 52 x 11 mm

Binnenschild | Inside plate
Innenschild | Plaque pour l'intérieur
248 x 52 x 8 mm

 GPF9204.09
 GPF1300



	
GPF 9317 09 532	🔑 55
GPF 9317 09 542	🔑 72
GPF 9317 09 562	🔑 92

	
GPF 9317 09 632	🔑 55
GPF 9317 09 642	🔑 72
GPF 9317 09 662	🔑 92

Met kerntrekbeveiliging extra veiligheid!

De kerntrekbeveiliging beschermt de cilinder tegen uitboren en uittrekken van de kern. In combinatie met een massief roestvast staal buitschild resulteert de kerntrekbeveiliging in een certificering van de zwaarste inbraakwerende klasse SKG***.

Knop wordt voormonteerd op schild.





Linkswijzend Pointing Left | Nach Links zeigend |
Main gauche



Rechtswijzend Pointing right | Nach Rechts zeigend |
Main droite





Inclusief bevestigingsset t.b.v. deurdikte 40 en 54 mm, overige: pag. 95.
Including fastenings for door thickness 40 and 54 mm, other: p. 95.
Inklusive Befestigung für den Türstärke 40 und 54 mm, Andere: ab Seite. 95.
Set de fixations inclus pour épaisseur de porte de 40 et 54mm, voir page 95.



GPF9327

Buitenschild | Outside plate
Außenschild | Plaque pour l'extérieur
257 x 35 x 11 mm

Binnenschild | Inside plate
Innenschild | Plaque pour l'intérieur
257 x 35 x 8 mm

-  GPF9206.09
-  GPF1015





	GPF 9327 09 542	Q 72
	GPF 9327 09 562	Q 92
	GPF 9327 09 642	Q 72
	GPF 9327 09 662	Q 92



GPF9337

Buitenschild | Outside plate
Außenschild | Plaque pour l'extérieur
257 x 35 x 11 mm

Binnenschild | Inside plate
Innenschild | Plaque pour l'intérieur
257 x 35 x 8 mm

-  GPF9208.09
-  GPF1300



	GPF 9337 09 542	Q 72
	GPF 9337 09 562	Q 92
	GPF 9337 09 642	Q 72
	GPF 9337 09 662	Q 92

With cylinder pulling protection extra security!

The cylinder pulling protection protects the cylinder against drilling and extraction. Combined with a solid stainless steel plate the core pulling protection resulting in certification of the toughest burglary resistant class SKG***.

Knob will be preassembled on plate.

Mit Kernziehschutz zusätzliche Sicherheit!

Das Kernziehschutz schützt den Zylinder gegen Aufbohren und Herausziehen des Kernes. In Kombination mit einen soliden Edelstahl-Außenschild resultierenden Kern bietet den Sicherheitszertifizierung von den härtesten einbruch-hemmenden Klasse SKG***.

Knopf werden auf Platte vormontiert.

Une sécurité ajoutée grâce à la protection contre l'extraction.

La protection contre l'extraction protège le cylindre contre le forage et l'extraction du rotor. La combinaison entre une plaque en inox massif et la protection contre l'extraction résulte en une certification SKG***.

Le bouton est prémonté sur la plaque.



GPF9845

Buitenschild | Outside plate
 Außenschild | Plaque pour l'extérieur
 248 x 52 x 11 mm

Binnenschild | Inside plate
 Innenschild | Plaque pour l'intérieur
 248 x 52 x 8 mm

GPF 9845 09 032	∅ 55
GPF 9845 09 042	∅ 72
GPF 9845 09 052	∅ 85
GPF 9845 09 062	∅ 92



GPF9312

Buitenschild | Outside plate
 Außenschild | Plaque pour l'extérieur
 248 x 52 x 11 mm

Binnenschild | Inside plate
 Innenschild | Plaque pour l'intérieur
 248 x 52 x 8 mm

GPF 9312 09 032	∅ 55
GPF 9312 09 042	∅ 72
GPF 9312 09 052	∅ 85
GPF 9312 09 062	∅ 92



GPF9308

Buitenschild | Outside plate
 Außenschild | Plaque pour l'extérieur
 248 x 52 x 11 mm

Binnenschild | Inside plate
 Innenschild | Plaque pour l'intérieur
 248 x 52 x 8 mm

GPF 9308 09 032	∅ 55
GPF 9308 09 042	∅ 72
GPF 9308 09 062	∅ 92



GPF9318

Buitenschild | Outside plate
 Außenschild | Plaque pour l'extérieur
 248 x 52 x 11 mm

Binnenschild | Inside plate
 Innenschild | Plaque pour l'intérieur
 248 x 52 x 8 mm

GPF 9318 09 032	∅ 55
GPF 9318 09 042	∅ 72
GPF 9318 09 062	∅ 92





Inclusief bevestigingsset t.b.v. deurdikte 40 en 54 mm, overige: pag. 95.

Including fastenings for door thickness 40 and 54 mm, other: p. 95.

Inklusive Befestigung für den Türstärke 40 und 54 mm, Andere: ab Seite. 95.

Set de fixations inclus pour épaisseur de porte de 40 et 54mm, voir page 95.

GPF9342

Buitenschild | Outside plate
Außenschild | Plaque pour l'extérieur
248 x 52 x 11 mm

Binnenschild | Inside plate
Innenschild | Plaque pour l'intérieur
248 x 52 x 8 mm



GPF 9342 09 042 | 72

GPF9352

Buitenschild | Outside plate
Außenschild | Plaque pour l'extérieur
248 x 52 x 11 mm

Binnenschild | Inside plate
Innenschild | Plaque pour l'intérieur
248 x 52 x 8 mm



GPF 9352 09 042 | 72

GPF9328

Buitenschild | Outside plate
Außenschild | Plaque pour l'extérieur
257 x 35 x 11 mm

Binnenschild | Inside plate
Innenschild | Plaque pour l'intérieur
257 x 35 x 8 mm



GPF 9328 09 042 | 72

GPF 9328 09 062 | 92

GPF9338

Buitenschild | Outside plate
Außenschild | Plaque pour l'extérieur
257 x 35 x 11 mm

Binnenschild | Inside plate
Innenschild | Plaque pour l'intérieur
257 x 35 x 8 mm



GPF 9338 09 042 | 72

GPF 9338 09 062 | 92





Volledige *keuzevrijheid* in het *samenstellen* van veiligheidsdeurbeslag en -raambeslag SKG***

Complete freedom in composing certified security door fittings and window fittings.

Völlige Freiheit in der Komposition Sicherheitstürbeschläge und Fensterbeschläge SKG ***

Une liberté totale dans le choix et la combinaison de garnitures de sécurité pour portes et fenêtres SKG***.

> Pagina 58

1

kies uw buitenschild

choose your outside plate
wählen Sie Ihren Außenschild
choisissez votre plaque pour
l'extérieur



2

kies uw binnenschild

choose your inside plate
wählen Sie Ihren Innenschild
choisissez votre plaque pour
l'intérieur



> Pagina 66

1

kies uw buitenrozet

choose your outside rose
wählen Sie Ihren Außenrosette
choisissez votre rosace pour
l'extérieur



2

kies uw binnenrozet

choose your inside rose
wählen Sie Ihren Innenrosette
choisissez votre rosace pour
l'intérieur





CombiVari[®]
HET FLEXIBELE DEURBESLAG



Met GPF CombiVari – het flexibele deurbeslag – maakt u zelf unieke combinaties met binnen en buiten veiligheidsbeslag.

GPF CombiVari – flexible door fittings – gives you the opportunity to mix and match inside and outside security fittings.

Mit GPF CombiVari - die flexiblen Türbeschläge - erstellen Sie einzigartige Kombinationen mit Innen und Außen Sicherheitsbeschläge.

La flexibilité de GPF CombiVari vous permet de créer des combinaisons uniques de garnitures de sécurité pour l'intérieur et l'extérieur.



3
kies uw knop/ kruk

choose your knob/ handle
wählen Sie Ihren Knopf / Drücker
choisissez votre bouton/béquille



3
kies uw voordeurknop

Choose your entrance knob/ handle
wählen Sie ihren Knopf / Drücker
choisissez votre bouton/ béquille
porte d'entrée



Raambeslag SKG*** pag. 48

Window fittings SKG*** p. 48
Fensterbeschläge SKG*** seite 48
Garnitures de fenêtres SKG***
de la page 48





choose your outside plate
wählen Sie Ihren Außenschild
choisissez votre plaque pour l'extérieur



kies uw buitenschild



GPF9002

248 x 52 x 11 mm



GPF9842

248 x 52 x 11 mm



GPF9012

248 x 52 x 11 mm



GPF9847

248 x 52 x 11 mm

GPF 9002 09 000	
GPF 9002 09 032	Q 55
GPF 9002 09 042	Q 72
GPF 9002 09 052	Q 85
GPF 9002 09 062	Q 92

GPF 9842 09 000	
GPF 9842 09 032	Q 55
GPF 9842 09 042	Q 72
GPF 9842 09 062	Q 92

GPF 9012 09 000	
GPF 9012 09 032	Q 55
GPF 9012 09 042	Q 72
GPF 9012 09 052	Q 85
GPF 9012 09 062	Q 92

GPF 9847 09 000	
GPF 9847 09 032	Q 55
GPF 9847 09 042	Q 72
GPF 9847 09 052	Q 85
GPF 9847 09 062	Q 92



GPF9042

248 x 52 x 11 mm



GPF9052

248 x 52 x 11 mm

GPF 9042 09 042	Q 72
-----------------	------

GPF 9052 09 042	Q 72
-----------------	------





GPF9008
248 x 52 x 11 mm

GPF 9008 09 032	🔑 55
GPF 9008 09 042	🔑 72
GPF 9008 09 062	🔑 92



GPF9018
248 x 52 x 11 mm

GPF 9018 09 032	🔑 55
GPF 9018 09 042	🔑 72
GPF 9018 09 062	🔑 92



GPF9028
257 x 35 x 11 mm

GPF 9028 09 042	🔑 72
GPF 9028 09 062	🔑 92



GPF9038
257 x 35 x 11 mm

GPF 9038 09 042	🔑 72
GPF 9038 09 062	🔑 92



KENMERKEN VAN EEN GPF VEILIGHEIDSSCHILD VOOR BUITEN:

- Met kerntrekbeveiliging van massief roestvast staal
- Zonder kerntrekbeveiliging van gegoten RVS met RVS cover
- Kerntrekbeveiliging
- GPF CombiVari concept: alles zelf samenstellen

FEATURES OF A GPF SECURITY PLATE FOR OUTSIDE:

- Cylinder pulling protection with a solid stainless steel plate
- Without cylinder pulling with RVS cover
- Cylinder pulling protection
- GPF CombiVari concept: your unique choice

MERKMALE EINER GPF SICHERHEITSSCHILD FÜR DEN AUSSENBEREICH:

- Mit Kernziehschutz aus massivem Edelstahl
- Ohne Kernziehschutz aus Edelstahl mit gegossenen Edelstahlabdeckung
- Kernziehschutz
- GPF CombiVari Konzept: alles selbst zusammen zu stellen

CARACTÉRISTIQUES DE LA PLAQUE DE SÉCURITÉ GPF POUR L'EXTÉRIEUR :

- Avec protection contre l'extraction du rotor en inox massif
- Sans protection contre l'extraction en inox fondu et plaque de recouvrement en inox
- Protection contre l'extraction du rotor
- Concept CombiVari : liberté de composition d'une garniture





kies uw binnenschild

choose your inside plate
wählen Sie Ihren Innenschild
choisissez votre plaque pour l'intérieur



GPF9102
248 x 52 x 8 mm



GPF9103
248 x 40 x 8 mm

GPF 9102 09 000	
GPF 9102 09 032	Q 55
GPF 9102 09 042	Q 72
GPF 9102 09 052	Q 85
GPF 9102 09 062	Q 92

GPF 9103 09 000	
GPF 9103 09 032	Q 55
GPF 9103 09 042	Q 72
GPF 9103 09 052	Q 85
GPF 9103 09 062	Q 92



GPF9112
248 x 52 x 8 mm



GPF9113
248 x 40 x 8 mm

GPF 9112 09 000	
GPF 9112 09 032	Q 55
GPF 9112 09 042	Q 72
GPF 9112 09 052	Q 85
GPF 9112 09 062	Q 92

GPF 9113 09 000	
GPF 9113 09 042	Q 72
GPF 9113 09 062	Q 92



GPF9142
248 x 52 x 8 mm



GPF9152
248 x 52 x 8 mm

GPF 9142 09 042	Q 72
-----------------	------

GPF 9152 09 042	Q 72
-----------------	------



KENMERKEN VAN EEN GPF VEILIGHEIDSSCHILD VOOR BINNEN:

- Gegoten RVS met RVS cover
- Verdekt geschroefd
- Links-/ rechtsverend
- Breedtemaat 52mm te combineren met buiten veiligheidsrozet
- GPF CombiVari concept: alles zelf samenstellen

FEATURES OF A GPF SECURITY PLATE FOR INSIDE:

- Stainless steel with stainless steel cover
- Concealed screw
- Left / right spring
- Width Size 52 mm combining outside security rose
- GPF Combi Vari concept: it's your choice.

MERKMALE EINER GPF SICHERHEITSSCHILD FÜR INNENAUSSTATTUNG:

- Edelstahl mit gegossenen Edelstahlabdeckung
- Verdeckt geschraubt
- Links / rechts Feder
- Breite 52mm zu kombinieren mit außwärts Sicherheits Rosette
- GPF CombiVari Konzept: alles selbst zusammen zu stellen

CARACTÉRISTIQUES D'UNE PLAQUE DE SÉCURITÉ GPF POUR L'INTÉRIEUR :

- Acier inoxydable massif
- Fixation invisible
- Réversible avec ressort de rappel
- Plaques pour l'intérieur en combinaison avec rosace de sécurité extérieur
- Concept CombiVari: liberté d'assemblage



GPF9128
257 x 35 x 8 mm



GPF9138
257 x 35 x 8 mm

GPF 9128 09 000	
GPF 9128 09 042	∅ 72
GPF 9128 09 062	∅ 92

GPF 9138 09 000	
GPF 9138 09 042	∅ 72
GPF 9138 09 062	∅ 92





kies uw knop/ kruk

choose your knob/ handle
wählen Sie Ihren Knopf / Drücker
choisissez votre bouton/béquille



GPF9852
52 x 16 mm



S4

S5

GPF 9852 09 410

GPF 9852 09 400

GPF9854
Ø 50 mm



S4

S5

GPF 9854 09 410

GPF 9854 09 400

GPF9860
Ø 60 x 16 mm

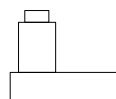

S4

S5

GPF 9860 09 410

GPF 9860 09 400

GPF9870
88/ Ø 55 x 24 mm



S4

S5

GPF 9870 09 410

GPF 9870 09 400



S4

Knop vast per stuk met M10 bout Fixed knob each | Knopf fest pro Stück mit Schraube M10 | Bouton fixe à la pièce avec boulon M10

S5

Knop vast per stuk met wisselstift Knob fixed with spindle each | Knopf fest pro Stück mit Wechselstift | Bouton fixe à la pièce avec carré à talon

GPF9856
53 x 53 mm



S4

S5

GPF 9856 09 410

GPF 9856 09 400

GPF9858
60 x 60 mm



S4

S5

GPF 9858 09 410

GPF 9858 09 400

GPF9202
90/ Ø52 x 13 mm

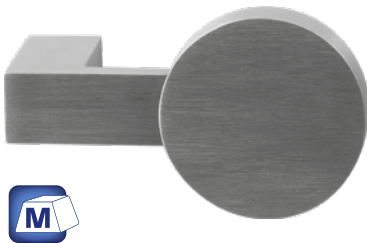

S4

S5

GPF 9202 09 410

GPF 9202 09 400

GPF9204
90/ 48 x 48 x 13 mm

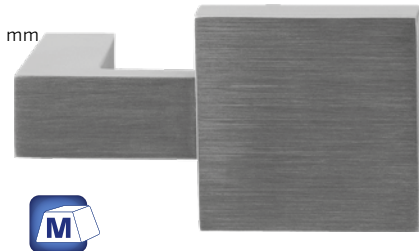

S4

S5

GPF 9204 09 410

GPF 9204 09 400

GPF9206
69/ Ø52 x 13 mm

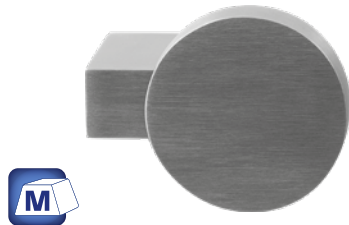

S4

S5

GPF 9206 09 410

GPF 9206 09 400

GPF9208
69/ 48 x 48 x 13 mm

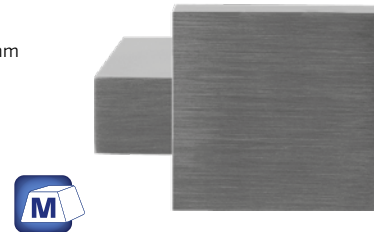

S4

S5

GPF 9208 09 410

GPF 9208 09 400



BEVESTIGING S4/ S5

Meer informatie op pag. 95.

FASTENINGS S4/ S5

More information on p. 95.

BEFESTIGUNG S4/ S5

Weitere Informationen ab Seite 95.

FIXATIONS S4/ S5

Plus d'info à partir de la page 95.



Inclusief bevestigingsset t.b.v. deurdikte 40 en 54 mm, overige: pag. 95.

Including fastenings for door thickness 40 and 54 mm, other: p. 95.

Inklusive Befestigung für den Türstärke 40 und 54 mm, Andere: ab Seite. 95.

Set de fixations inclus pour épaisseur de porte de 40 et 54mm, voir page 95.



M MASSIEF

Alle buiten veiligheidsrozetten zijn van massief roestvast staal.

SOLID

All outside security roses are made of solid stainless steel.

MASSIV

Alle Sicherheits-Außenrosette sind aus massivem Edelstahl.

MASSIF

Toutes les rosaces de sécurité extérieur sont en acier inoxydable massif.

GPF9390 09 199



GPF9820 09 199



GPF9821 09 199



GPF9390 49 199

Gepolijst | Mirror | Poliërt | Poli



GPF9820 49 199

Gepolijst | Mirror | Poliërt | Poli



GPF9821 49 199

Gepolijst | Mirror | Poliërt | Poli



GPF9385 09 199

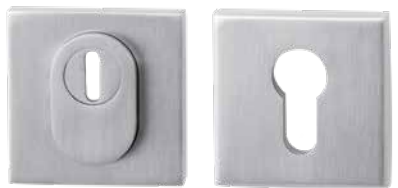

GPF9815 09 199



GPF9816 09 199



GPF9815 49 199

Gepolijst | Mirror | Poliërt | Poli



GPF9816 49 199

Gepolijst | Mirror | Poliërt | Poli





kies uw buitenrozet

choose your outside rose
wählen Sie Ihren Außenrosette
choisissez votre rosace pour l'extérieur



Knop vast Fixed knob | Knopf fest | Bouton fixe



Rozet Rose | Rosette | Rosace

GPF9288 09 199



GPF9280 09 199



GPF9282 09 199

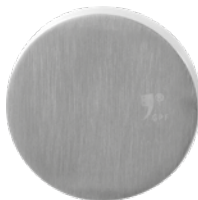

GPF9292 09 199



GPF9284 09 199



GPF9286 09 199



GPF9288 49 199
Gepolijst | Mirror |
Poliert | Poli



GPF9280 49 199
Gepolijst | Mirror |
Poliert | Poli



GPF9282 49 199
Gepolijst | Mirror |
Poliert | Poli



GPF9284 49 199
Gepolijst | Mirror |
Poliert | Poli



GPF9286 49 199
Gepolijst | Mirror |
Poliert | Poli



MASSIEF

Alle buiten veiligheidsrozetten zijn van massief roestvast staal.

SOLID

All outside security roses are made of solid stainless steel.

MASSIV

Alle Sicherheits-Außenrosette sind aus massivem Edelstahl.

MASSIF

Toutes les rosaces de sécurité extérieur sont en acier inoxydable massif.



**Ronde rozetten Ø 55 x 10 mm
Vierkante rozetten 55 x 55 x 10 mm.**

Round roses Ø 55 x 10 mm.
Square roses 55 x 55 x 10 mm.

Rundrosetten Ø 55 x 10 mm.
Quereck Rosetten 55 x 55 x 10 mm.

Rosaces rondes Ø 55 x 10 mm.
Rosaces carrées 55 x 55 x 10 mm.



Inclusief bevestigingsset t.b.v. deurdikte 40 en 54 mm, overige: pag. 95.

Including fastenings for door thickness 40 and 54 mm, other: p. 95.

Inklusive Befestigung für den Türstärke 40 und 54 mm, Andere: ab Seite. 95.

Set de fixations inclus pour épaisseur de porte de 40 et 54mm, voir page 95.



GPF9819 09 199



GPF9819 49 199

Gepolijst | Mirror |
Poliert | Poli



GPF9814 09 199



GPF9814 49 199

Gepolijst | Mirror |
Poliert | Poli



3

choose your entrance knob/ handle
wählen Sie ihren Knopf / Drücker
choisissez votre bouton porte d'entrée

kies uw voordeurknop

GPF9822.09



	○	◎
GPF 9822 09 400	63	63
GPF 9823 09 400	70	70
GPF 9824 09 400	100	70

GPF9825.09

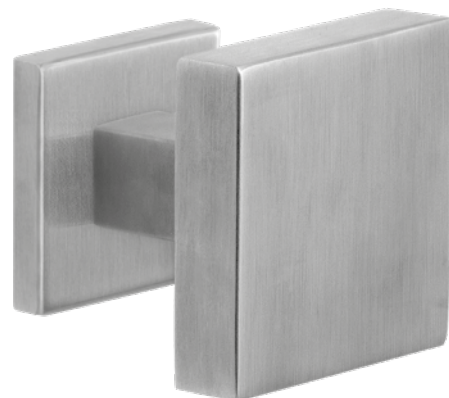

	○	◎
GPF 9825 09 400	70x70x16	53x53x8

GPF9834 09 000
350 x 100 x 3 mm



GPF9838 09 000
350 x 100 x 3 mm



GPF9830 09 400
340 x 77 mm



150 mm / 110 mm

26
d

GPF 9800 09 000	0
GPF 9801 09 000	1
GPF 9802 09 000	2
GPF 9803 09 000	3
GPF 9804 09 000	4
GPF 9805 09 000	5
GPF 9806 09 000	6/9
GPF 9807 09 000	7
GPF 9808 09 000	8
GPF 9809 09 000	9
GPF 9810 09 000	a
GPF 9811 09 000	b
GPF 9812 09 000	c
GPF 9813 09 000	d

Ø 10 x 130 mm / 80 mm

56
78

GPF 9880 09 000	0
GPF 9881 09 000	1
GPF 9882 09 000	2
GPF 9883 09 000	3
GPF 9884 09 000	4
GPF 9885 09 000	5
GPF 9886 09 000	6
GPF 9887 09 000	7
GPF 9888 09 000	8
GPF 9893 09 000	9
GPF 9889 09 000	a
GPF 9890 09 000	b
GPF 9891 09 000	c
GPF 9892 09 000	d



GPF9826 09 400
Ø 50 x 8 mm



GPF9827 09 400
Ø 50x8mm



GPF9826 05 400
Ø 50 x 6 mm



GPF9827 05 400
Ø 50 x 6 mm



GPF9826 02 400
50 x 50 x 8 mm



GPF9827 02 400
50 x 50 x 8 mm



GPF9826 04 400
65 x 30 x 10 mm



GPF9827 04 400
65 x 30 x 10 mm



GPF9826 06 400
Ø 50 x 2 mm



GPF9827 06 400
Ø 50 x 2 mm



GPF9826 03 400
80 x 38 x 2 mm



GPF9827 03 400
80 x 38 x 2 mm



GPF9826 08 400
50 x 50 x 2 mm



GPF9827 08 400
50 x 50 x 2 mm



GPF9826 40 400
Ø 50 x 8 mm



GPF9827 40 400
Ø 50 x 8 mm



GPF9826 45 400
Ø 50 x 6 mm



GPF9827 45 400
Ø 50 x 6 mm



GPF9826 42 400
50 x 50 x 8 mm



GPF9827 42 400
50 x 50 x 8 mm



GPF9826 46 400
Ø 50 x 2 mm



GPF9827 46 400
Ø 50 x 2 mm



GPF9826 43 400
80 x 38 x 2 mm



GPF9827 43 400
80 x 38 x 2 mm



GPF9826 48 400
50 x 50 x 2 mm



GPF9827 48 400
50 x 50 x 2 mm



[GRIP OP

Van ons private label bieden wij een breed programma grepen aan in roestvast staal.

*Met ruim 150 typen deurgrepen, uit voorraad leverbaar, is ons programma **een van de grootste van Nederland!***

[GRIP ON PULL HANDLES]

Our private label offers a wide range of stainless steel pull handles.

With more than 150 types of door pull handles, from stock, our program is one of the largest in the Netherlands!

[ZUGRIFF AUF GRIFFE]

Mit unseren Private-Label, bieten wir eine breite Palette von Edelstahl-Griffe.

Mit mehr als 150 Arten Türgriffe, ab Lager lieferbar, ist unser Programm einer der größten in den Niederlanden!

GREPEN]

[SOUS L'EMPRISE DES
POIGNÉES DE TIRAGE]

Sous notre label, nous proposons un large programme de poignées de tirage en acier inoxydable.

Avec plus de 150 types d'articles de stock, notre programme est un des plus fournis des Pays-Bas.

Ook deurgrepen op maat!

Also custom made pull handles!

Auch maßgeschneiderte Griffe!

Poignées de tirage également sur mesure!

Bevestiging bestaat uit 2 stuks
 Fastening consists 2 pieces
 Befestigung besteht aus 2 Stück
 La fixation comprend 2 pièces

- ØA | **Diameter greep** Diameter grip | Durchmesser Griff | Diamètre de la poignée de tirage
- ØB | **Diameter nek** Diameter neck | Durchmesser Hals | Diamètre du col
- Ø | **Diameter rozet** Diameter rose | Durchmesser rosette | Diamètre rosace



Grepen worden geleverd exclusief bevestiging. Kies hiernaast een bevestiging naar keuze.

Fastenings
 Door handles excluding fastenings. Choose on the right fastenings of your choice.

Befestigungen
 Griffe sind ohne Montagesätze geliefert. Wählen Sie rechts Montagesätze Ihrer wahl.

Fixations
 Les spoignées de tirage sont livrées sans fixations. Choisissez les fixations désirées ci-contre.

Enkelzijdige montage - Door de deur

One-sided mounting through door | Seitige Montage durch der Tür | Montage à la pièce à travers de la porte



	ØA/B
GPF 9957 EB 000	20, 25, 32, 38

Enkelzijdige montage - Door de deur - Met rozet

One-sided mounting through door with rose | Seitige Montage durch der Tür mit Rosette | Montage à la pièce à travers de la porte avec rosace

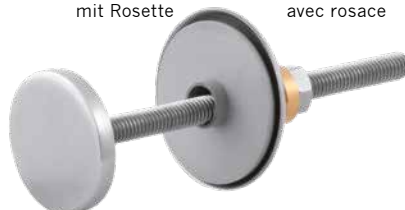

	ØA	Ø
GPF 9955 EB 000	25	32
GPF 9956 EB 000	32	38

Dubbelzijdige montage - Door de deur

Double-sided mounting through door | Doppelseitige Montage durch der Tür | Montage à la paire à travers de la porte



	ØA/B
GPF 9967 DB 000	20, 25, 32, 38

Dubbelzijdige montage - Door de deur - Met rozet

Double-sided mounting through door with rose | Doppelseitige Montage durch der Tür mit Rosette | Montage à la paire à travers de la porte avec rosace



	ØA	Ø
GPF 9965 DB 000	25	32
GPF 9966 DB 000	32	38

Blinde montage

Blind mounting | Blindmontage | Montage à fixation non traversante



	ØA/B
GPF 9958 BB 000	16
GPF 9959 BB 000	20, 25, 32, 38



Lengte Length | Länge | Longueur



Hart op hart Centre to Centre | Mitte zu Mitte | Entraxe

GPF 01



	ØA	↕	⋈
GPF 9497 09 701	20	320	300
GPF 9498 09 701	20	370	350
GPF 9499 09 701	20	420	400
GPF 9500 09 701	25	325	300
GPF 9505 09 701	25	375	350
GPF 9506 09 701	25	425	400
GPF 9510 09 701	32	332	300
GPF 9520 09 701	32	382	350
GPF 9525 09 701	32	632	600
GPF 9528 09 701	32	832	800
GPF 9530 09 701	38	1038	1000
GPF 9532 09 701	38	1238	1200

GPF 02



	ØA	↕	⋈
GPF 9540 09 702	25	225	200

GPF 03



	ØA	↕	⋈
GPF 9555 09 703	25	325	300
GPF 9560 09 703	32	332	300

GPF 05



	ØA	↕	⋈
GPF 9580 09 705	25	225	200
GPF 9585 09 705	32	332	300
GPF 9590 09 705	32	382	350

GPF 06



	ØA	↕	⋈
GPF 9592 09 706	25	325	300
GPF 9594 09 706	32	332	300
GPF 9596 09 706	32	382	350

GPF 07



	ØA	↕	⋈
GPF 9600 09 707	25	325	300
GPF 9605 09 707	32	332	300

ØA **Diameter greep** Diameter grip | Durchmesser Griff | Diamètre de la poignée de tirage

ØB **Diameter nek** Diameter neck | Durchmesser Hals | Diamètre du col

↕ **Lengte** Length | Länge | Longueur

⌘ **Hart op hart** Centre to Centre | Mitte zu Mitte | Entraxe

GPF 09



	ØA	↕	⌘
GPF 9620 09 709	25	225	100

GPF 10



	ØA	↕	⌘
GPF 3600 09 710	22	300	200
GPF 3602 09 710	22	400	300
GPF 3604 09 710	22	500	350
GPF 3606 09 710	22	600	400
GPF 3608 09 710	22	800	600
GPF 3610 09 710	30	300	200
GPF 3612 09 710	30	400	300
GPF 3614 09 710	30	500	350
GPF 3616 09 710	30	600	400
GPF 3618 09 710	30	800	600

GPF 11



	ØA	↕	⌘
GPF 3630 09 711	22	300	278
GPF 3632 09 711	22	400	378
GPF 3634 09 711	22	500	478
GPF 3636 09 711	22	600	578
GPF 3638 09 711	22	800	778
GPF 3640 09 711	30	300	270
GPF 3642 09 711	30	400	370
GPF 3644 09 711	30	500	470
GPF 3646 09 711	30	600	570
GPF 3648 09 711	30	800	770

GPF 12



	ØA	↕	⌘
GPF 9630 09 712	32	600	568

GPF 15

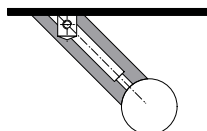

	ØA	↕	⌀	ØB
GPF 9655 K1 715	25	350	250	22
GPF 9660 K1 715	25	350	300	22
GPF 9664 K1 715	25	450	350	22
GPF 9665 K1 715	25	500	350	22
GPF 9670 K2 715	32	450	350	22
GPF 9670 K3 715	32	450	350	25
GPF 9671 K2 715	32	500	350	22
GPF 9671 K3 715	32	500	350	25
GPF 9672 K2 715	32	640	440	22
GPF 9672 K3 715	32	640	440	25
GPF 9673 K2 715	32	810	610	22
GPF 9673 K3 715	32	810	610	25
GPF 9675 K4 715	38	810	610	25
GPF 9676 K4 715	38	1200	1000	25
GPF 9677 K4 715	38	1400	1200	25
GPF 9678 K4 715	38	1600	1400	25
GPF 9679 K4 715	38	1800	1600	25
GPF 9674 K4 715	38	2000	1800	25

GPF 16



	ØA	↕	⌀
GPF 9646 09 716	16	198	128
GPF 9647 09 716	16	230	160
GPF 9650 09 716	20	300	200
GPF 9651 09 716	20	350	250
GPF 9654 09 716	20	450	350
GPF 9655 09 716	25	350	250
GPF 9660 09 716	25	350	300
GPF 9664 09 716	25	450	350
GPF 9665 09 716	25	500	350
GPF 9670 09 716	32	450	350
GPF 9671 09 716	32	500	350
GPF 9672 09 716	32	640	440
GPF 9673 09 716	32	810	610
GPF 9675 09 716	38	810	610
GPF 9676 09 716	38	1200	1000
GPF 9677 09 716	38	1400	1200
GPF 9678 09 716	38	1600	1400
GPF 9679 09 716	38	1800	1600
GPF 9674 09 716	38	2000	1800

ØA **Diameter greep** Diameter grip | Durchmesser Griff | Diamètre du tirant

ØB **Diameter nek** Diameter neck | Durchmesser Hals | Diamètre du col

↑ **Lengte** Length | Länge | Longueur

⌘ **Hart op hart** Centre to Centre | Mitte zu Mitte | Entraxe

GPF 17



	ØA	↑	⌘
GPF 9680 09 717	20	420	400

GPF 18

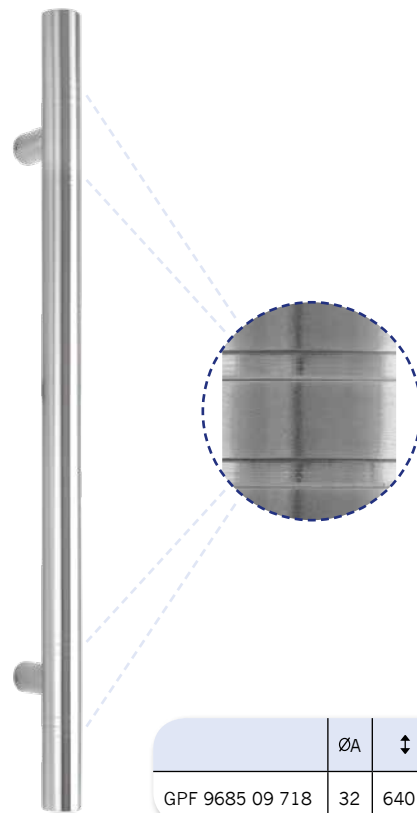

	ØA	↑	⌘
GPF 9685 09 718	32	640	440

GPF 19



	ØA	↑	⌘
GPF 9686 09 719	16	144	128
GPF 9687 09 719	16	176	160
GPF 9681 09 719	20	320	300
GPF 9682 09 719	20	370	350
GPF 9683 09 719	20	420	400
GPF 9689 09 719	25	325	300
GPF 9690 09 719	25	350	325
GPF 9691 09 719	25	375	350
GPF 9692 09 719	25	425	400
GPF 9695 09 719	32	432	400
GPF 9696 09 719	32	632	600
GPF 9697 09 719	32	832	800
GPF 9698 09 719	32	1032	1000
GPF 9699 09 721	32	1232	1200

GPF 20

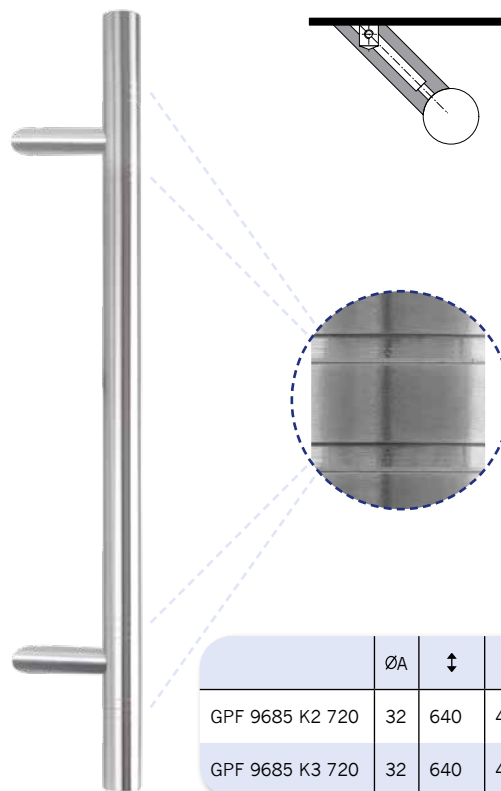

	ØA	↑	⌘	ØB
GPF 9685 K2 720	32	640	440	22
GPF 9685 K3 720	32	640	440	25

GPF 21



	ØA	↓	ⓘ
GPF 9700 09 722	25	600	300

GPF 23



	ØA	↓	ⓘ
GPF 9725 09 723	25	365	300

De diversiteit in vorm en materiaal geeft u veel keuzemogelijkheden. Ook is een deel van de grepen verkropt (onder een hoek) te monteren. Kiest u voor roestvast staal mat geborsteld of voor duo met gepolijste delen?

DOOR HANDLES

The diversity in form and material gives you many choices. Also, a part of our pull handles are suitable to assemble at an angle. Do you choose stainless steel satin of the combination satin/mirror?

TÜRDRÜCKER

Die Vielfalt in Form und Material bietet Ihnen viele Wahl Möglichkeiten. Auch ist ein Teil der Griffe verkropt zu montieren (schräg). Wählen Sie aus matt gebürstetem Edelstahl oder kombiniert mit polierten Teile?

POIGNÉES DE TIRAGE

La diversité des formes et des matériaux permettent d'innombrables possibilités. Une partie des poignées de tirage peut être monté déporté. Vous choisissez l'inox brossé mat ou une combinaison de brossé mat/polé?

ØA **Diameter greep** Diameter grip | Durchmesser Griff | Diamètre de la poignée de tirage

▽ **Afmeting driehoek** Size triangle | Großer Triangle | Dimension triangulaire

○ **Afmeting ovaal** Size Oval | Großer Oval | Dimension ovale

↕ **Lengte** Length | Länge | Longueur

⋮ **Hart op hart** Centre to Centre | Mitte zu Mitte | Entraxe

GPF 25 Duo

Mat/ gepolijst | Satin/ mirror | Matt/ poliert | Mat/poli



	▽	↕	⋮
GPF 9770 09 725	40x36	800	500
GPF 9775 09 725	40x36	1000	700

GPF 30 Duo

Mat/ gepolijst | Satin/ mirror | Matt/ poliert | Mat/poli



	○	↕	⋮
GPF 9780 09 730	20x38	800	500
GPF 9785 09 730	20x38	1000	700

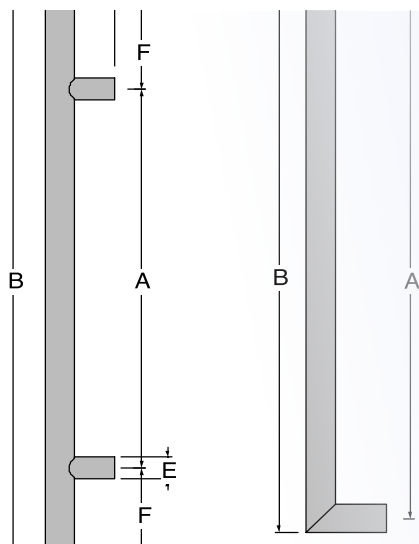

Deurgrepen, als specifiek maatwerk

Om de vraag van specifiek maatwerk tegemoet te komen is er GPF FlexiVari, deurgreep op maat. Binnen GPF FlexiVari zijn een aantal RVS modellen opgenomen die te personaliseren zijn naar uw individuele wensen. Of u kiest voor een compleet eigen ontwerp!

Vraag ons naar de mogelijkheden.



GPF 35



Per paar incl. bevestiging
Per pair including fastenings
Pro Paar inklusive Befestigung.
A la paire fixations comprises.

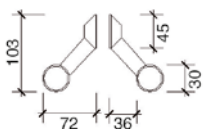

	ØA	↑	↓
GPF 9790 09 735	30	500	320

GPF 40



Per paar incl. bevestiging
Per pair including fastenings
Pro Paar inklusive Befestigung.
A la paire fixations comprises.

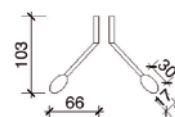

	ØA	↑	↓
GPF 9795 09 740	17X30	500	320

GPF 70 Duo

Mat/ gepolijst | Satin/ mirror | Matt/ poliert | Mat/poli



	ØA	↑	↓
GPF 9750 09 770	32	350	318
GPF 9755 09 770	25,4	300	274,6

GPF 75 Duo

Mat/ gepolijst | Satin/ mirror | Matt/ poliert | Mat/poli



	ØA	↑	↓
GPF 9760 09 775	25,4	234	208,6

Door handles, as a specific customization

GPF FlexiVari, has an answer to the question of specifically customized pull handles.

Within GPF Flexi Vari are some stainless steel models included which can be personalized to your individual needs. You may choose a completely unique design!

Ask us for more information.

Türgriffe, massgeschneidet

Um die Frage eines massgeschneidetet Modell entgegen zu kommen ist GPF FlexiVari ein Türgriff nach Mass.

Innerhalb GPF FlexiVari gibt es einige Modelle aus Edelstahl, die auf Ihren individuellen Wunsch personalisiert werden können. Egal, ob Sie ein komplett eigenes Design wählen!

Fragen Sie uns nach die Möglichkeiten.

Poignées de tirage, du sur mesure

Pour répondre à la demande spécifique de poignées de tirage sur mesure, GPF introduit le FlexiVari.

GPF FlexiVari propose plusieurs modèles de poignées de tirage en inox qui sont personnalisables à souhait.

Renseignez-vous sur les possibilités.

∅ **Diameter** Diameter | Durchmesser | Diamètre

↔ **Hoogte** Height | Höhe | Hauteur

GPF5500



	∅	↔
GPF 5500 09 020	20	25
GPF 5500 09 025	25	30
GPF 5500 09 030	30	35

GPF5505



	∅	↔
GPF 5505 09 020	20	27
GPF 5505 09 025	25	32
GPF 5505 09 030	30	40
GPF 5505 09 035	35	46

GPF5510



	∅	↔
GPF 5510 09 020	20	23
GPF 5510 09 025	25	28
GPF 5510 09 030	30	32
GPF 5510 09 035	35	35

GPF5515



	∅	↔
GPF 5515 09 020	20	28
GPF 5515 09 025	25	30
GPF 5515 09 030	30	32
GPF 5515 09 035	35	38

GPF5520



	∅	↔
GPF 5520 09 020	20	16
GPF 5520 09 025	25	20
GPF 5520 09 030	30	24
GPF 5520 09 035	35	28

GPF5525



	∅	↔
GPF 5525 09 020	20	33
GPF 5525 09 025	25	39
GPF 5525 09 030	30	49

GPF5530



	∅	↔
GPF 5530 09 020	20	25
GPF 5530 09 025	25	33
GPF 5530 09 030	30	37

GPF5535

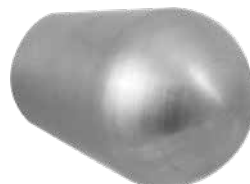

	∅	↔
GPF 5535 09 020	20	28
GPF 5535 09 025	25	35
GPF 5535 09 030	30	42

GPF5540



	∅	↔
GPF 5540 09 020	20	30
GPF 5540 09 025	25	38
GPF 5540 09 030	30	45

GPF5545



	∅	↔
GPF 5545 09 020	20	19
GPF 5545 09 025	25	24
GPF 5545 09 030	30	28

GPF5550



	∅	↔
GPF 5550 09 020	20	18
GPF 5550 09 025	25	21
GPF 5550 09 030	30	28
GPF 5550 09 035	35	32

GPF5555/ 5560



	∅	↔
GPF 5555 09 020	20	34
GPF 5555 09 025	25	37
GPF 5560 09 030	30	40
GPF 5560 09 035	35	45

GPF5565



	∅	↔
GPF 5565 09 035	9	30
GPF 5565 09 040	10	40
GPF 5565 09 045	12	45



MASSIEF

Alle meubelknoppen zijn massief roestvast staal.

SOLID

All furniture knobs are made of solid stainless steel.

MASSIV

Alle möbelknöpfe sind aus massivem Edelstahl

MASSIF

Tous les boutons de meuble sont en acier inoxydable massif.



	ØA	↔	∞∞
GPF 5009 09 781	10	160	96
GPF 5010 09 781	10	190	128
GPF 5011 09 781	10	220	160
GPF 5012 09 781	10	288	224
GPF 5013 09 781	10	385	320
GPF 5022 09 781	12	156	96
GPF 5023 09 781	12	188	128
GPF 5025 09 781	12	220	160
GPF 5026 09 781	12	250	192
GPF 5027 09 781	12	284	224
GPF 5029 09 781	12	380	320
GPF 5030 09 781	12,7	400	340
GPF 5031 09 781	12,7	500	440
GPF 5032 09 781	12,7	540	480
GPF 5033 09 781	12,7	600	540
GPF 5034 09 781	12,7	700	640
GPF 5035 09 781	12,7	800	740
GPF 5036 09 781	12,7	900	840
GPF 5037 09 781	12,7	1100	1040



	ØA	↔	∞∞
GPF 5090 09 787	12	108	96
GPF 5091 09 787	12	140	128
GPF 5092 09 787	12	172	160
GPF 5093 09 787	12	204	192
GPF 5094 09 787	12	236	224
GPF 5095 09 787	12	300	288
GPF 5096 09 787	12	332	320



	ØA	↔	∞∞
GPF 5000 09 780	10	115	96
GPF 5001 09 780	10	152	128
GPF 5002 09 780	10	190	160
GPF 5003 09 780	10	237	192
GPF 5004 09 780	10	236	224



	ØA	↔	∞∞
GPF 5040 09 782	10	114	96
GPF 5041 09 782	10	153	128



	ØA	↔	∞∞
GPF 5050 09 783	10	84	64
GPF 5051 09 783	10	115	96
GPF 5052 09 783	10	145	128



ØA **Diameter greep** Diameter grip | Durchmesser Griff | Diamètre du tirant

↔ **Lengte** Length | Länge | Longueur

∞ **Hart op hart** Centre to Centre | Mitte zu Mitte | Entraxe



	ØA	↔	∞
GPF 5060 09 784	8	58	48
GPF 5070 09 784	8	72	64
GPF 5071 09 784	8	104	96
GPF 5072 09 784	8	136	128
GPF 5073 09 784	8	168	160
GPF 5074 09 784	8	200	192
GPF 5080 09 786	10	74	64
GPF 5081 09 786	10	106	96
GPF 5082 09 786	10	138	128
GPF 5083 09 786	10	170	160
GPF 5084 09 786	10	202	192
GPF 5085 09 786	10	234	224
GPF 5086 09 786	10	330	320



	ØA	↔	∞
GPF 5200 09 000	8	104	96
GPF 5201 09 000	8	136	128
GPF 5202 09 000	8	168	160
GPF 5203 09 000	8	200	192
GPF 5204 09 000	8	264	256
GPF 5205 09 000	8	328	320
GPF 5210 09 000	10	106	96
GPF 5211 09 000	10	138	128
GPF 5212 09 000	10	170	160
GPF 5213 09 000	10	202	192
GPF 5214 09 000	10	266	256
GPF 5215 09 000	10	330	320



	ØA	↔	∞
GPF 5100 09 000	10	110	96
GPF 5101 09 000	10	142	128
GPF 5102 09 000	10	174	160
GPF 5103 09 000	10	206	196
GPF 5104 09 000	10	270	256
GPF 5105 09 000	10	334	320



	ØA	↔	∞
GPF 5150 09 000	9	150	96
GPF 5151 09 000	9	180	128
GPF 5152 09 000	9	215	160
GPF 5153 09 000	9	250	192
GPF 5155 09 000	9	280	224



	ØA	↔	∞
GPF 5110 09 000	15	50	32



GPF0721 09 000
Ø 44 x 25 mm



GPF0725 09 000
Ø 35 x 40 mm



GPF0740 09 000
Ø 80 x 60 mm
2kg



GPF0726 09 000
Ø 45 x 40 mm



GPF0727 09 000
Ø 35 x 52 mm



GPF0730 09 000
Ø 65 mm



GPF0731 09 000
Ø 63 mm

GPF0728 09 000
Ø 40 x 40 mm



GPF0724 09 000
Ø 40 x 40 mm



GPF0729 09 000
Ø 50 x 85 mm



GPF0400 09 830
Ø 75 mm



GPF0405 09 830
Ø 75 mm



GPF0410 09 830
Ø 75 mm



GPF0415 09 830
Ø 75 mm



GPF0420 09 830
Ø 75 mm



GPF0425 09 830
Ø 75 mm



GPF0450 09 831
125 x 125 mm



GPF0455 09 831
125 x 125 mm



GPF0460 09 831
125 x 125 mm



GPF0465 09 831
125 x 125 mm



GPF0470 09 831
125 x 125 mm



GPF0475 09 831
125 x 125 mm





GPF0710



	∅
GPF 0710 09 00A	65
GPF 0710 09 00B	50
GPF 0710 09 00C	40

GPF0711



	∅
GPF 0711 09 000	90

GPF0713



GPF 0713 09 000	120x40
-----------------	--------

GPF0716



GPF 0716 09 00A	120x40
GPF 0716 09 00B	120x50
GPF 0716 09 00C	150x50
GPF 0716 09 00D	180x60

GPF0714



GPF 0714 09 00A	30x30
GPF 0714 09 00B	40x40
GPF 0714 09 00C	50x50
GPF 0714 09 00D	60x60
GPF 0714 09 00E	70x70
GPF 0714 09 00F	90x90

GPF0712



GPF 0712 09 000	100x50
-----------------	--------

GPF0715



GPF 0715 09 00A	120x40
GPF 0715 09 00B	120x50
GPF 0715 09 00C	150x50
GPF 0715 09 00D	180x60

GPF0717



GPF 0717 09 00A	102x51
-----------------	--------

GPF0201 09 813
Ø 35 mm



GPF0202 09 813
Ø 24,5 mm



GPF0810 09 000
70 x 70 x 10 mm



GPF0800 09 000
80 x 90 mm



GPF0820 09 000
125 x 20 x 3 mm



GPF0821 09 000
48 x 20 x 3 mm



GPF0822 09 000
Ø 35 mm



GPF0823 09 000
Ø 58 mm





Linksdraaiend (DIN links) Left turning | Linksdrehend | poussant gauche (din droite)

Rechtsdraaiend (DIN rechts) Right turning | Rechtsdrehend | Poussant droite (din gauche)



GPF 0343 09 500	90x90	
GPF 0344 09 600	90x90	



GPF 0345 09 500	90x90	
GPF 0346 09 600	90x90	

GPF0701 09 000
Ø 76 x 12 mm



GPF0702 09 000
Ø 75 x 17 mm



GPF0704 09 000
62 x 45 mm



GPF0705 09 000
48 x 38 mm



GPF0780 09 000
 Ø 64 x 75 mm



GPF0785 09 000
 Ø 75 x 80 mm



GPF0790 09 000
 Ø 62 x 70 mm



GPF0770

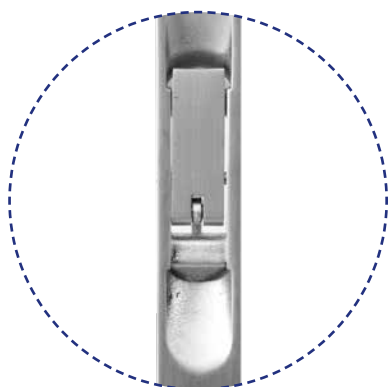

GPF0703 09 000
 89 x 89 mm



GPF 0770 09 00A	200x19
GPF 0770 09 00B	250x19
GPF 0770 09 00C	300x19

GPF9400 09 000
175 x 375 mm



GPF9405 09 000
330 x 375 mm



GPF9410 09 000
335 x 438 mm



GPF9415 09 000
470 x 315 mm



GPF9425 09 000
410 x 390 mm



GPF9440 09 000
406 x 380 mm



GPF9450 09 000
500 x 360 mm



GPF9480 09 000
300 x 210 mm



GPF9450 09 000
480 x 360 mm



GPF9490 09 000
285 x 115 mm



GPF9462 09 000
1700 x Ø 50 mm



GPF9495 09 000
420 x 75 mm



De weergegeven symbolen in deze brochure staan voor:

The symbols shown in this brochure are for:

Die in dieser Broschüre dargestellten Symbole sind für:

Les symboles dans la brochure représentent :



Algemene informatie

General Information • Allgemeine Informationen • Informations générales



Montage

Mounting • Montage • Montage



Onderhoud

Maintenance • Wartung • Entretien



Maatvoering

Dimensions • Größe • Mesures



Veiligheid en kwaliteit

Safety and quality • Sicherheit und Qualität • Sécurité et qualité



MATERIAAL & FINISH

De moderne look wordt aangevoerd door het gebruik van RVS materialen. Het GPF roestvast staal assortiment voldoet helemaal aan deze lifestyle. Minder is meer en in samenhang met de functionaliteit geeft het stijl en schoonheid in een modern interieur. De GPF roestvast staal producten zijn gemaakt van roestvast staal 304 en makkelijk in onderhoud. Ze lenen zich bij uitstek om zowel binnen als buiten toegepast te worden.

MATERIAL & FINISH

The modern look is led by the use of stainless steel materials. The GPF stainless steel range complements this lifestyle. Less is more, and in conjunction with the functionality gives it the style and beauty in a modern interior. The GPF stainless steel products are made of 304 stainless steel and easy to maintain. They are ideally suited to be used inside and outside.

WERKSTOFF UND OBERFLÄCHE

Das modernen Aussehen wird durch die Verwendung von Edelstahlmaterialien realisiert. Das GPF Edelstahl Sortiment erfüllt diesen lifestyle. Weniger ist mehr, und in Kombination mit der Funktionalität gibt es den Still und die Schönheit in einem modernen Innenraum. Die GPF Edelstahlprodukte sind aus 304 Edelstahl und leicht zu warten. Sie sind für den Innen- und Außenbereich geeignet.

MATERIAU ET FINITION

L'utilisation de l'inox procure un look moderne et de ce fait la gamme GPF inox cadre tout à fait dans ce style. La sobriété associée à la fonctionnalité procure un certain cachet à votre intérieur moderne. Les produits en inox sont fabriqués en acier inoxydable 304 et sont faciles à entretenir. Ils se prêtent très bien à l'emploi à l'intérieur comme à l'extérieur.



GPF VEILIGHEIDSBESLAG SKG***

GPF veiligheidsbeslag (vanaf pagina 48) is gecertificeerd. SKG*** is de hoogste inbraakwerende klasse en staat voor ten minste vijf minuten inbraakvertraging. De eisen om dit keurmerk te dragen hebben betrekking op o.a.:

- veiligheid
- werking van het beslag
- duurzaamheid
- corrosiebestendigheid
- temperatuurbestendigheid
- inbraakwerendheid

GPF SAFETY FITTINGS

GPF security fittings (from p. 48) are certified. SKG *** is the highest burglary resistant class there is and withstands burglary for at least five minutes. The requirements to wear this label include:

- security
- operation
- durability
- corrosion resistance
- temperature resistance
- burglary

GPF SICHERHEITS-BESCHLÄGE

GPF Sicherheits-Beschläge (ab Seite 48) ist zertifiziert. SKG*** ist die höchste einbruchhemmende Klasse und es gibt eine Einbruchverzögerung von mindestens fünf Minuten. Die Anforderungen, die dieses Label verlangt sind ausführlich und betreffen u.a.:

- sicherheit
- wirkung des Beschläge
- dauerhaftigkeit
- korrosionsbeständigkeit
- temperaturbeständigkeit
- einbruchhemmung

GARNITURES DE SECURITE GPF

Les garnitures de sécurité GPF (voir à partir de la page 48) sont certifiées SKG***. SKG*** est le label de sécurité le plus élevé et garanti au minimum 5 minutes de retard d'effraction. Les exigences pour accéder à ce label de qualité portent sur:

- la sécurité
- le fonctionnement
- la résistance à l'usure
- la résistance à la corrosion
- la résistance à une température élevée
- la résistance à l'effraction





KERNTREKBEVEILIGING

De nieuwe eis van het Politie Keurmerk Veilig Wonen (PKVW) schrijft voor nieuwbouw kerntrekbeveiliging voor. Het GPF veiligheidsbeslag SKG*** met kerntrekbeveiliging voldoet volledig aan deze eis. Bekijk het programma kerntrek vanaf pag. 52.

CYLINDER PULLING PROTECTION

The new requirement of the Dutch security label PKVW requires cylinder pulling protection for new buildings. The GPF security fittings SKG *** with cylinder pulling protection fully meets this requirement. See the program cylinder pulling protecting from p. 52.

KERNZIEHSCHUTZ

Die neue Anforderung von Politie Keurmerk Veilig Wonen (PKVW) erfordert Kernziehschutz für Neubau. Die GPF Sicherheitsschutzbeschläge SKG *** mit Kernziehschutz erfüllt vervollständig diese Anforderung. Siehe das Programm Kernziehschutz von Seite 52.

PROTECTION CONTRE L'EXTRACTION

Le label PKVW (Politie Keurmerk Veilig Wonen) prescrit la protection contre l'extraction du rotor pour toute nouvelle construction. Les garnitures de sécurité GPF SKG*** avec protection contre l'extraction répondent parfaitement à cette exigence. Consultez le programme protection extraction à partir de la page 52.



MASSIEF

Producten met dit symbool zijn van massief roestvast staal:



SOLID

All products with this icon are made of solid stainless steel.

MASSIV

Produkte mit diesem Symbol sind aus massivem Edelstahl.

MASSIF

Ce symbole signifie que les produits sont en acier inoxydable massif.



MAATVOERING SCHILDEN

Voor schildensets is de bepaling van de profielcilinder (PC), sleutelgat (BB) of vrij/bezet (WC) maat belangrijk voor een juiste bestelling.

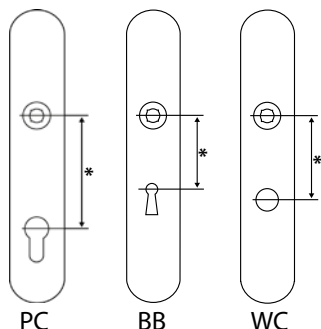

*** Hart op hart maat in mm**
 Centre to centre in mm
 Mitte zu Mitteabstand in mm
 Entraxes, mesures en mm

DIMENSIONS PLATES

The dimension of the profile cylinder, keyhole or privacy bolt in plates is important for your product order.

GROSSE DER SCHILDER

Es ist wichtig die Bestimmung des Zylinders, Schlüsselloch oder WC-Größe für eine richtigen Bestellung.

DIMENSIONS DES PLAQUES

Le cylindre profilé, le trou de la serrure et le choix de la rosace libre/occupé sont importants lors de la commande de plaques.



GPF COMBIVARI

Alle GPF deurkrukken passen op de GPF rozetten en schilden. In drie stappen maakt u uw set deurbeslag compleet. Meer informatie en producten vanaf pagina 8.

Ook met GPF veiligheidsbeslag kiest u zelf welk veiligheidsschild of -rozet u binnen of buiten toepast met een GPF deurknop of deurkruk naar keuze. Meer informatie en producten vanaf pagina 57.

GPF COMBIVARI

GPF CombiVari gives you the opportunity to mix and match door handles with any rose of plate to reflect your individual style and choice. More information and products from p. 8.

GPF CombiVari also fits the GPF security fittings. Choose which plate or rose you want inside or outside with a GPF knob or door handles of your choice. More information and products from p. 57.

GPF COMBIVARI

Alle Griffe passen auf alle GPF Rosetten und Schilder. In drei Schritten machen Sie Ihren Satz Türbeschläge vollständig. Weitere Informationen und Produkte ab Seite 8.

Auch mit GPF Sicherheitsbeschläge, wählen Sie selbst, welche Schild oder Rosette Sie Innen oder Außen mit GPF Knopf oder Türdrücker kombinieren. Weitere Informationen und Produkte ab Seite 57.

GPF COMBIVARI

Toutes les béquilles GPF sont adaptées à toutes les plaques et rosaces GPF. Vous composez votre garniture pour porte en trois étapes. Plus d'info et articles à partir de la page 8.

Dans la gamme GPF vous choisissez également la plaque ou la rosace de sécurité pour l'intérieur ou l'extérieur avec bouton ou béquille au choix. Plus d'info à partir de la page 57.



VERPAKKING

Alle producten worden in beschermende verpakking en samengesteld geleverd, inclusief bevestigingsmiddelen.

PACKING

All products are delivered in protective packaging and include fastenings.

VERPAKKUNG

Alle Produkte werden in einer Schutzverpackung geliefert und vormontiert und sind einschließlich Befestigungsmittel.

EMBALLAGE

Tous les produits sont livrés avec les accessoires de fixation dans un emballage protégé.



WEBSITE

Voor meer informatie over GPF bouwbeslag producten: www.tenhulscher.com

WEBSITE

For more information about GPF bouwbeslag products: www.tenhulscher.com

WEBSITE

Für weitere Informationen über GPF Baubeschläge-Produkte: www.tenhulscher.com

SITE WEB

Plus d'informations sur les produits GPF sur www.tenhulscher.com

EXTRA BEVESTIGINGSSETS

Bestel extra bevestigingssets voor veiligheidsbeslag uit de volgende tabellen:

ADDITIONAL FASTENINGS KITS

Order additional fastening kits for security fittings from the following tables:

EXTRA MONTAGESÄTZE

Bestellen Sie zusätzliche Montagesätze für Sicherheitsbeschläge aus den folgenden Tabellen:

SETS DE FIXATIONS SUPPLEMENTAIRES

Commandez des sets de fixations supplémentaires pour les articles de sécurité suivants:

Veiligheidsrozetten

Safety roses
Sicherheit Rosetten
Rosaces de sécurité

Veiligheidsschilden

Safety plates
Schutzschilder
Plaques de sécurité

Veiligheidsschildenmet knop vast buiten/ knop of kruk draaibaar binnen

Safety plates with outside fixed knob/ inside rotatable knob or handle.
Schutzschilder mit Knopf fest Außen/ Knopf oder Griff drehbar Innen.
Plaques de sécurité avec combinaison bouton fixe extérieur/bouton tournant ou béquille intérieur

Veiligheidsschilden kruk/ kruk combinatie

Safety plates handle/ knob combination
Schutzschilder Griff/ Griff Kombination.
Plaque de sécurité avec combinaison béquille/béquille

AG0300	40mm
AG0305	54mm
AG0310	68mm

AG0315	40mm
AG0320	54mm
AG0325	68mm

AG0316	40mm
AG0321	54mm
AG0326	68mm

AG0317	40mm
AG0322	54mm
AG0327	68mm

BEVESTIGING S1/ S2/ S3/ S4/ S5

S1 Knop draaibaar per paar
S2 Knop vast per stuk met knopvastzetter
S3 Knop vast per stuk met M10 bout
S4 Knop vast per stuk met M10 bout
S5 Knop vast per stuk met wisselstift



FASTENINGS S1/ S2/ S3 /S4/ S5

S1 Rotatable knob per pair
S2 Knob fixed with knob fastener each
S3 Knob fixed with M10 screw each
S4 Knob fixed with M10 screw each
S5 Knob fixed with spindle each

BEFESTIGUNG S1/ S2/ S3 /S4/ S5

S1 Knopf drehbar pro Paar
S2 Knopf fest pro Stück mit Verschluss
S3 Knopf fest pro Stück mit Schraube M10
S4 Knopf fest pro Stück mit Schraube M10
S5 Knopf fest pro Stück mit Wechselstift

FIXATIONS S1/ S2/ S3 /S4/ S5

S1 Bouton tournant à la paire
S2 Bouton fixe à la pièce avec rosace de montage bouton fixe
S3 Bouton fixe à la pièce avec boulon M10
S4 Bouton fixe à la pièce avec boulon M10
S5 Bouton fixe à la pièce avec carré à talon

RVS PATENTSCHROEVEN

T.b.v. 2 mm schilden & rozetten op pag. 38 - 45.

PATENT SCREWS

For 2 mm plates & roses on p. 38 - 45.

PATENT SCHRAUBEN

Für 2 mm Schilder und rosetten ab Seite 38 - 45.

BOULON DE BREVETS

Pour 2 mm plaques et rosaces voir page 38 - 45.



		T.b.v. deurdikte For door thickness Für den Türstärke Pour épaisseur de porte
AG0345	M4x35 mm	32 · 38 mm
AG0350	M4x40 mm	37 · 43 mm
AG0352	M4x50 mm	47 · 53 mm
AG0355	M4x55 mm	52 · 58 mm
AG0360	M4x65 mm	62 · 68 mm

ONDERHOUD

Producten van roestvast staal dient u regelmatig af te nemen met een vochtige doek. U kunt er ook voor kiezen om een roestvast staalcleaner te gebruiken. Dit laatste zorgt ervoor dat er een bescherm laagje wordt aangebracht op het product.

Het kan voorkomen dat producten van roestvast staal ogen alsof ze roesten. Dit is het zogenaamde vlogroest. Hierbij zijn kleine ijzerdeeltjes uit de lucht neergeslagen op de producten; dit is dus geen roest vanuit de producten. Vlogroest kunt u gemakkelijk verwijderen met de Scotch Brite schuurspons. U dient er wel op te letten dat u wrijft in de richting van de borsteling.

Houten delen

Behandel hout nooit met agressieve schoonmaak-/schuurmiddelen of verfverduuners.

MAINTENANCE

Stainless steel products need to be treated periodically with a moist cloth. A stainless steel cleaner ensures that a protective layer is applied to the product

It is possible that stainless steel products may appear to be rusting. This is caused by small airborne iron particles. It is not rust from the product. These rust spots can be easily removed with the Scotch Brite scouring pad. You should ensure that you rub in the direction of the satin brushing.

Wooden parts

Never treat wood or any of our products with aggressive cleaning/ cleaners or paint thinners.

PFLEGE

Produkte aus Edelstahl müssen regelmässig mit einem feuchten Tuch abgenommen werden oder Sie verwenden einen Edelstahlreiniger. Das Letztere gewährleistet, dass es eine Schutzschicht auf das Produkt wird aufgebracht.

Es ist möglich, dass Produkte aus Edelstahl de Anschein haben als ob die rosten, dies wird auch Flugrost genannt. Es sind oft kleine Eisenpartikel aus der Luft, niedergeschlagen auf die Produkte, und ist daher kein Rost von den Produkten selber. Flugrost kann leicht entfernt werden mit einen Scotch-Brite Scheuerschwamm. Sie sollten aber beachten dass Sie mit in die Richtung des Schleifkornes reiben.

Holzteile

Holz niemals mit aggressiven Reinigungs-/ schleifmittel oder Farbverdüner bearbeiten.

ENTRETIEN

L'entretien d'articles en acier inoxydable se fait à l'aide d'un chiffon humide avec ou sans produit d'entretien pour l'inox. Ce dernier a cependant l'avantage de déposer une couche protectrice sur l'article.

Parfois, de petites particules ferrugineuses peuvent se déposer sur l'inox lui procurant un aspect légèrement rouillé. Vous vous débarrasserez facilement de cette fine couche de particules à l'aide d'une éponge à récurer Scotch Brite. Veillez à toujours frotter dans le sens du brossé.

Parties en bois

Ne traitez jamais les parties en bois avec un produit d'entretien abrasif ou agressif ni avec un diluant.

DRAAIRICHTINGEN

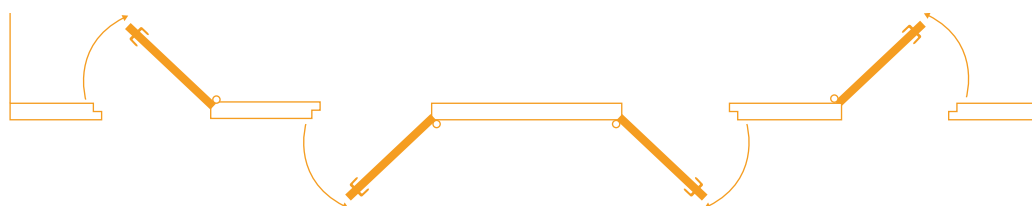

DIN links
Binnendraaiend

DIN rechts
Buitendraaiend

DIN links
Buitendraaiend

DIN rechts
Binnendraaiend



SCHUREN EN SCHILDEREN

Bij schuur- en schilderwerkzaamheden dient u altijd het beslag te verwijderen. Bij deurkrukken ook de onderrozetten. Monteer het beslag enkele dagen na het schilderen, wanneer de verf is uitgehard. Alleen dan kunt u probleemloos van uw deur- raam- en meubelbeslag genieten.

SANDING AND PAINTING

When sanding and painting, always remove the stainless steel products, including the rose under it. Refit them several days after painting when the paint has dried. By following this procedure your door, window and furniture fittings will remain decorative and functional for many years.

SCHLEIFEN UND LACKIEREN

Beim Schleifen und Lackieren der Türen oder Fenster, immer die Beschläge komplett von der Tür entfernen. Setzen Sie die Beschläge erst einige Tage nach dem Lackieren zurück, wenn der Lack ausgehärtet ist. Nur dann können Sie ohne Probleme von Ihren Tür-Fenster- und Möbelbeschlägen genießen.

PONCER, DECAPER ET PEINDRE

Enlevez toujours les ferrures et garnitures avant tous travaux de peinture ou de réparation. Ne les remontez qu'après quelques jours, une fois la peinture complètement sèche.



SCOTCH BRITE SCHUURSPONS

Artikelnummer: AG0900 220 x 160 mm t.b.v mat geborsteld roestvast staal.

Gebbruiksaanwijzing:

- Schuur altijd met de borstelrichting van het product mee.
- Demonteer het product van deur/ raam/ meubel voordat u het gaat schuren.



SCOTCH BRITE SCOURING PAD

Order number: AG0900 220 x 160 mm for satin brushed stainless steel.

Instructions:

- Rub always in the direction of the product satin brushing.
- Remove the product from door/ window/ cabinet before you start scouring.

SCOTCH-BRITE SCHEUERSCHWAMM

Artikelnummer: AG0900 220 x 160 mm für matt gebürstetem Edelstahl.

Gebrauchsanweisung:

- Schleifbürste immer in der Bürsterichtung des Produkts bewegen.
- Die Beschläge der Tür/ Fenster/ Schrank komplett demontieren, bevor Sie eine Schleifarbeit auf die Teile anfangen.

EPONGE A RECUPER SCOTCH BRITE

N° d'article : AG0900 220 x 160 mm, pour inox brossé mat

Mode d'emploi

- Récurer toujours dans le sens du brossé
- Démontez les articles avant d'effectuer l'entretien.



Ten Hulscher bv

Speulderweg 38-40
3886 LB Garderen

P.O. Box 16
3886 ZG Garderen

+31 (0)577 46 23 07

+31 (0)577 46 23 00

sales@tenhulscher.com

www.tenhulscher.com

www.tenhulscher.com

AG0300	95	GPF 0715 09 00B	86	GPF 0902 02 108	38	GPF 0910 48 110	40
AG0305	95	GPF 0715 09 00C	86	GPF 0902 04 108	38	GPF 0910 49 109	40
AG0310	95	GPF 0715 09 00D	86	GPF 0902 05 108	38	GPF 0911 00 110	38
AG0315	95	GPF 0716 09 00A	86	GPF 0902 06 108	39	GPF 0911 02 110	38
AG0316	95	GPF 0716 09 00B	86	GPF 0902 07 108	38	GPF 0911 05 110	38
AG0317	95	GPF 0716 09 00C	86	GPF 0902 08 108	39	GPF 0911 06 110	39
AG0320	95	GPF 0716 09 00D	86	GPF 0902 09 108	39	GPF 0911 07 110	38
AG0321	95	GPF 0717 09 00A	86	GPF 0902 40 108	39	GPF 0911 08 110	39
AG0322	95	GPF 0721 09 000	84	GPF 0902 42 108	39	GPF 0911 09 109	39
AG0325	95	GPF 0724 09 000	84	GPF 0902 45 107	40	GPF 0911 40 110	39
AG0326	95	GPF 0725 09 000	84	GPF 0902 46 107	40	GPF 0911 42 110	39
AG0327	95	GPF 0726 09 000	84	GPF 0902 47 107	40	GPF 0911 45 110	40
AG0345	96	GPF 0727 09 000	84	GPF 0902 48 107	40	GPF 0911 46 110	40
AG0350	96	GPF 0728 09 000	84	GPF 0902 49 108	40	GPF 0911 47 110	40
AG0352	96	GPF 0729 09 000	84	GPF 0903 00 109	38	GPF 0911 48 110	40
AG0355	96	GPF 0730 09 000	84	GPF 0903 02 109	38	GPF 0911 49 109	40
AG0360	96	GPF 0731 09 000	84	GPF 0903 05 109	38	GPF 1000 01 100	8
AG0900	9	GPF 0740 09 000	84	GPF 0903 06 109	39	GPF 1001 01 100	8
GPF 0201 09 813	87	GPF 0770 09 00A	89	GPF 0903 07 109	38	GPF 1001 01 200	47
GPF 0202 09 813	87	GPF 0770 09 00B	89	GPF 0903 08 109	39	GPF 1005 01 100	8
GPF 0343 09 500	88	GPF 0770 09 00C	89	GPF 0903 09 109	39	GPF 1006 01 100	8
GPF 0344 09 600	88	GPF 0780 09 000	89	GPF 0903 40 109	39	GPF 1010 01 100	8
GPF 0345 09 500	88	GPF 0785 09 000	89	GPF 0903 42 109	39	GPF 1015 01 100	8
GPF 0346 09 600	88	GPF 0790 09 000	89	GPF 0903 45 109	40	GPF 1016 01 100	8
GPF 0400 09 830	85	GPF 0800 09 000	87	GPF 0903 46 109	40	GPF 1020 01 100	8
GPF 0405 09 830	85	GPF 0810 09 000	87	GPF 0903 47 109	40	GPF 1025 01 100	9
GPF 0410 09 830	85	GPF 0820 09 000	87	GPF 0903 48 109	40	GPF 1030 01 100	9
GPF 0415 09 830	85	GPF 0821 09 000	87	GPF 0903 49 109	40	GPF 1035 01 100	9
GPF 0420 09 830	85	GPF 0822 09 000	87	GPF 0904 00 109	38	GPF 1037 01 100	9
GPF 0425 09 830	85	GPF 0823 09 000	87	GPF 0904 02 109	38	GPF 1040 01 100	9
GPF 0450 09 831	85	GPF 0900 00 000	38	GPF 0904 05 109	38	GPF 1040 01 200	47
GPF 0455 09 831	85	GPF 0900 02 000	38	GPF 0904 06 109	39	GPF 1042 01 100	9
GPF 0460 09 831	85	GPF 0900 05 000	38	GPF 0904 07 109	38	GPF 1045 01 100	12
GPF 0465 09 831	85	GPF 0900 06 000	39	GPF 0904 08 109	39	GPF 1047 01 100	12
GPF 0470 09 831	85	GPF 0900 08 000	39	GPF 0904 09 109	39	GPF 1055 01 100	12
GPF 0475 09 831	85	GPF 0900 40 000	39	GPF 0904 40 109	39	GPF 1060 01 100	12
GPF 0701 09 000	88	GPF 0900 42 000	39	GPF 0904 42 109	39	GPF 1065 01 100	12
GPF 0702 09 000	88	GPF 0900 46 000	40	GPF 0904 45 109	40	GPF 1075 01 100	12
GPF 0703 09 000	89	GPF 0900 48 000	40	GPF 0904 46 109	40	GPF 1080 01 100	12
GPF 0704 09 000	88	GPF 0901 00 107	38	GPF 0904 47 109	40	GPF 1085 01 100	12
GPF 0705 09 000	88	GPF 0901 02 107	38	GPF 0904 48 109	40	GPF 1090 01 100	13
GPF 0710 09 00A	86	GPF 0901 05 107	38	GPF 0904 49 109	40	GPF 1095 01 100	13
GPF 0710 09 00B	86	GPF 0901 06 107	39	GPF 0910 00 110	38	GPF 1100 00 100	38
GPF 0710 09 00C	86	GPF 0901 07 107	38	GPF 0910 02 110	38	GPF 1100 00 100	20
GPF 0711 09 000	86	GPF 0901 08 107	39	GPF 0910 05 110	38	GPF 1100 02 100	38
GPF 0712 09 000	86	GPF 0901 09 107	39	GPF 0910 06 110	39	GPF 1100 03 100	38
GPF 0713 09 000	86	GPF 0901 40 107	39	GPF 0910 07 110	38	GPF 1100 04 100	38
GPF 0714 09 00A	86	GPF 0901 42 107	39	GPF 0910 08 110	39	GPF 1100 05 100	38
GPF 0714 09 00B	86	GPF 0901 45 107	40	GPF 0910 09 109	39	GPF 1100 06 100	39
GPF 0714 09 00C	86	GPF 0901 46 107	40	GPF 0910 40 110	39	GPF 1100 06 100	20
GPF 0714 09 00D	86	GPF 0901 47 107	40	GPF 0910 42 110	39	GPF 1100 08 100	39
GPF 0714 09 00E	86	GPF 0901 48 107	40	GPF 0910 45 110	40	GPF 1100 09 100	39
GPF 0714 09 00F	86	GPF 0901 49 107	40	GPF 0910 46 110	40	GPF 1100 10 100	11
GPF 0715 09 00A	86	GPF 0902 00 108	38	GPF 0910 47 110	40	GPF 1100 10 101	42

GPF 1100 10 111	42	GPF 1100 22 111	43	GPF 1100 35 200	46	GPF 1110 49 109	41
GPF 1100 10 132	42	GPF 1100 22 132	43	GPF 1100 35 300	46	GPF 1111 09 109	41
GPF 1100 10 142	42	GPF 1100 22 142	43	GPF 1100 40 100	39	GPF 1111 49 109	41
GPF 1100 10 857	42	GPF 1100 22 857	43	GPF 1100 42 100	39	GPF 1300 01 100	13
GPF 1100 10 863	42	GPF 1100 22 863	43	GPF 1100 43 100	40	GPF 1300 01 200	47
GPF 1100 10 884	42	GPF 1100 22 884	43	GPF 1100 45 100	40	GPF 1305 01 100	13
GPF 1100 10 885	42	GPF 1100 22 885	43	GPF 1100 46 100	40	GPF 1310 01 100	13
GPF 1100 12 100	42	GPF 1100 23 100	43	GPF 1100 48 100	40	GPF 1315 01 100	13
GPF 1100 12 101	42	GPF 1100 23 101	43	GPF 1100 49 100	40	GPF 1320 01 100	13
GPF 1100 12 111	42	GPF 1100 23 111	43	GPF 1100 53 100	47	GPF 1325 01 100	14
GPF 1100 12 132	42	GPF 1100 23 132	43	GPF 1100 54 100	47	GPF 1330 01 100	14
GPF 1100 12 142	42	GPF 1100 23 142	43	GPF 1100 55 200	46	GPF 1335 01 100	14
GPF 1100 12 857	42	GPF 1100 23 857	43	GPF 1100 55 300	46	GPF 1340 01 100	14
GPF 1100 12 863	42	GPF 1100 23 863	43	GPF 1100 60 100	43	GPF 1800 01 200	48
GPF 1100 12 884	42	GPF 1100 23 884	43	GPF 1100 60 101	43	GPF 1800 01 300	48
GPF 1100 12 885	42	GPF 1100 23 885	43	GPF 1100 60 111	43	GPF 1990 01 100	14
GPF 1100 15 100	44	GPF 1100 25 100	21	GPF 1100 60 132	43	GPF 2025 01 100	14
GPF 1100 15 101	44	GPF 1100 25 101	44	GPF 1100 60 142	43	GPF 2030 01 100	14
GPF 1100 15 111	44	GPF 1100 25 111	44	GPF 1100 60 857	43	GPF 2035 01 100	14
GPF 1100 15 132	44	GPF 1100 25 132	44	GPF 1100 60 863	43	GPF 2035 01 300	49
GPF 1100 15 142	44	GPF 1100 25 142	44	GPF 1100 60 884	43	GPF 2065 01 100	15
GPF 1100 15 857	44	GPF 1100 25 857	44	GPF 1100 60 885	43	GPF 2075 01 100	15
GPF 1100 15 863	44	GPF 1100 25 863	44	GPF 1100 65 100	45	GPF 2077 01 100	15
GPF 1100 15 884	44	GPF 1100 25 884	44	GPF 1100 65 101	45	GPF 2080 01 100	15
GPF 1100 15 885	44	GPF 1100 25 885	44	GPF 1100 65 111	45	GPF 2080 01 200	49
GPF 1100 16 100	44	GPF 1100 26 100	44	GPF 1100 65 132	45	GPF 2082 01 100	15
GPF 1100 16 101	44	GPF 1100 26 101	44	GPF 1100 65 142	45	GPF 2085 01 100	18
GPF 1100 16 111	44	GPF 1100 26 111	44	GPF 1100 65 857	45	GPF 2095 01 100	18
GPF 1100 16 132	44	GPF 1100 26 132	44	GPF 1100 65 863	45	GPF 3000 01 100	18
GPF 1100 16 142	44	GPF 1100 26 142	44	GPF 1100 65 884	45	GPF 3010 01 100	18
GPF 1100 16 857	44	GPF 1100 26 857	44	GPF 1100 65 885	45	GPF 3020 01 100	18
GPF 1100 16 863	44	GPF 1100 26 863	44	GPF 1100 70 100	43	GPF 3022 01 100	18
GPF 1100 16 884	44	GPF 1100 26 884	44	GPF 1100 70 101	43	GPF 3025 01 100	18
GPF 1100 16 885	44	GPF 1100 26 885	44	GPF 1100 70 111	43	GPF 3030 01 100	18
GPF 1100 20 100	42	GPF 1100 27 100	45	GPF 1100 70 132	43	GPF 3035 01 100	19
GPF 1100 20 101	42	GPF 1100 27 101	45	GPF 1100 70 142	43	GPF 3037 01 100	19
GPF 1100 20 111	42	GPF 1100 27 111	45	GPF 1100 70 857	43	GPF 3040 01 100	19
GPF 1100 20 132	42	GPF 1100 27 132	45	GPF 1100 70 863	43	GPF 3045 01 100	19
GPF 1100 20 142	42	GPF 1100 27 142	45	GPF 1100 70 884	43	GPF 3050 01 100	19
GPF 1100 20 857	42	GPF 1100 27 857	45	GPF 1100 70 885	43	GPF 3085 01 100	19
GPF 1100 20 863	42	GPF 1100 27 863	45	GPF 1100 75 100	45	GPF 3100 01 100	22
GPF 1100 20 884	42	GPF 1100 27 884	45	GPF 1100 75 101	45	GPF 3105 01 100	22
GPF 1100 20 885	42	GPF 1100 27 885	45	GPF 1100 75 111	45	GPF 3110 01 100	22
GPF 1100 21 100	42	GPF 1100 28 100	45	GPF 1100 75 132	45	GPF 3115 01 100	22
GPF 1100 21 101	42	GPF 1100 28 101	45	GPF 1100 75 142	45	GPF 3120 01 100	22
GPF 1100 21 111	42	GPF 1100 28 111	45	GPF 1100 75 857	45	GPF 3125 01 100	22
GPF 1100 21 132	42	GPF 1100 28 132	45	GPF 1100 75 863	45	GPF 3130 01 100	22
GPF 1100 21 142	42	GPF 1100 28 142	45	GPF 1100 75 884	45	GPF 3510 01 100	37
GPF 1100 21 857	42	GPF 1100 28 857	45	GPF 1100 75 885	45	GPF 3510 01 400	37
GPF 1100 21 863	42	GPF 1100 28 863	45	GPF 1105 09 109	41	GPF 3510 01 410	37
GPF 1100 21 884	42	GPF 1100 28 884	45	GPF 1105 49 109	41	GPF 3515 01 100	37
GPF 1100 21 885	42	GPF 1100 28 885	45	GPF 1108 09 109	41	GPF 3515 01 400	37
GPF 1100 22 100	43	GPF 1100 30 100	47	GPF 1108 49 109	41	GPF 3515 01 410	37
GPF 1100 22 101	43	GPF 1100 31 100	47	GPF 1110 09 109	41	GPF 3520 01 100	36

GPF 3520 01 400	36	GPF 4051 01 100	26	GPF 4246 01 100	27	GPF 4678 09 310	32
GPF 3520 01 410	36	GPF 4052 01 100	26	GPF 4248 01 100	27	GPF 4680 09 310	32
GPF 3525 01 100	36	GPF 4100 41 100	28	GPF 4249 01 100	27	GPF 4685 09 310	32
GPF 3525 01 400	36	GPF 4101 41 100	28	GPF 4251 01 100	27	GPF 4686 09 310	32
GPF 3525 01 410	36	GPF 4105 41 100	28	GPF 4252 01 100	27	GPF 4687 09 310	32
GPF 3600 09 710	74	GPF 4106 41 100	28	GPF 4300 41 100	29	GPF 4688 09 310	32
GPF 3602 09 710	74	GPF 4110 41 100	28	GPF 4301 41 100	29	GPF 4689 09 310	32
GPF 3604 09 710	74	GPF 4111 41 100	28	GPF 4305 41 100	29	GPF 4900 49 00A	35
GPF 3606 09 710	74	GPF 4112 41 100	28	GPF 4306 41 100	29	GPF 4900 49 00B	35
GPF 3608 09 710	74	GPF 4113 41 100	28	GPF 4310 41 100	29	GPF 4900 49 00C	35
GPF 3610 09 710	74	GPF 4115 41 100	28	GPF 4311 41 100	29	GPF 4901 49 00A	35
GPF 3612 09 710	74	GPF 4116 41 100	28	GPF 4312 41 100	29	GPF 4901 49 00B	35
GPF 3614 09 710	74	GPF 4118 41 100	28	GPF 4313 41 100	29	GPF 4901 49 00C	35
GPF 3616 09 710	74	GPF 4119 41 100	28	GPF 4315 41 100	29	GPF 4905 49 00A	35
GPF 3618 09 710	74	GPF 4121 41 100	28	GPF 4316 41 100	29	GPF 4905 49 00B	35
GPF 3630 09 711	74	GPF 4122 41 100	28	GPF 4318 41 100	29	GPF 4905 49 00C	35
GPF 3632 09 711	74	GPF 4130 01 100	26	GPF 4319 41 100	29	GPF 4906 49 00A	35
GPF 3634 09 711	74	GPF 4130 01 200	33	GPF 4321 41 100	29	GPF 4906 49 00B	35
GPF 3636 09 711	74	GPF 4131 01 100	26	GPF 4322 41 100	29	GPF 4906 49 00C	35
GPF 3638 09 711	74	GPF 4135 01 100	26	GPF 4330 01 100	27	GPF 4910 49 00A	35
GPF 3640 09 711	74	GPF 4136 01 100	26	GPF 4331 01 100	27	GPF 4910 49 00B	35
GPF 3642 09 711	74	GPF 4140 01 100	26	GPF 4335 01 100	27	GPF 4910 49 00C	35
GPF 3644 09 711	74	GPF 4141 01 100	26	GPF 4336 01 100	27	GPF 4911 49 00A	35
GPF 3646 09 711	74	GPF 4142 01 100	26	GPF 4340 01 100	27	GPF 4911 49 00B	35
GPF 3648 09 711	74	GPF 4143 01 100	26	GPF 4341 01 100	27	GPF 4911 49 00C	35
GPF 4000 41 100	28	GPF 4145 01 100	26	GPF 4342 01 100	27	GPF 4912 49 00A	35
GPF 4001 41 100	28	GPF 4146 01 100	26	GPF 4343 01 100	27	GPF 4912 49 00B	35
GPF 4005 41 100	28	GPF 4148 01 100	26	GPF 4345 01 100	27	GPF 4912 49 00C	35
GPF 4006 41 100	28	GPF 4149 01 100	26	GPF 4346 01 100	27	GPF 4913 49 00A	35
GPF 4010 41 100	28	GPF 4151 01 100	26	GPF 4348 01 100	27	GPF 4913 49 00B	35
GPF 4011 41 100	28	GPF 4152 01 100	26	GPF 4349 01 100	27	GPF 4913 49 00C	35
GPF 4012 41 100	28	GPF 4200 41 100	29	GPF 4351 01 100	27	GPF 4915 49 00A	35
GPF 4013 41 100	28	GPF 4201 41 100	29	GPF 4352 01 100	27	GPF 4915 49 00B	35
GPF 4015 41 100	28	GPF 4205 41 100	29	GPF 4610 49 310	33	GPF 4915 49 00C	35
GPF 4016 41 100	28	GPF 4206 41 100	29	GPF 4615 49 310	33	GPF 4916 49 00A	35
GPF 4018 41 100	28	GPF 4210 41 100	29	GPF 4620 49 310	33	GPF 4916 49 00B	35
GPF 4019 41 100	28	GPF 4211 41 100	29	GPF 4625 49 310	33	GPF 4916 49 00C	35
GPF 4021 41 100	28	GPF 4212 41 100	29	GPF 4630 49 310	33	GPF 4918 49 00A	35
GPF 4022 41 100	28	GPF 4213 41 100	29	GPF 4635 49 310	33	GPF 4918 49 00B	35
GPF 4030 01 100	26	GPF 4215 41 100	29	GPF 4637 49 310	33	GPF 4918 49 00C	35
GPF 4030 01 200	32	GPF 4216 41 100	29	GPF 4638 49 310	33	GPF 4919 49 00A	35
GPF 4031 01 100	26	GPF 4218 41 100	29	GPF 4640 49 310	33	GPF 4919 49 00B	35
GPF 4035 01 100	26	GPF 4219 41 100	29	GPF 4645 49 310	33	GPF 4919 49 00C	35
GPF 4036 01 100	26	GPF 4221 41 100	29	GPF 4646 49 310	33	GPF 4921 49 00A	35
GPF 4040 01 100	26	GPF 4222 41 100	29	GPF 4647 49 310	33	GPF 4921 49 00B	35
GPF 4041 01 100	26	GPF 4230 01 100	27	GPF 4648 49 310	33	GPF 4921 49 00C	35
GPF 4042 01 100	26	GPF 4231 01 100	27	GPF 4649 49 310	33	GPF 4922 49 00A	35
GPF 4043 01 100	26	GPF 4235 01 100	27	GPF 4650 09 310	32	GPF 4922 49 00B	35
GPF 4045 01 100	26	GPF 4236 01 100	27	GPF 4655 09 310	32	GPF 4922 49 00C	35
GPF 4046 01 100	26	GPF 4240 01 100	27	GPF 4660 09 310	32	GPF 4930 09 00A	34
GPF 4048 01 100	26	GPF 4241 01 100	27	GPF 4665 09 310	32	GPF 4930 09 00B	34
GPF 4049 01 100	26	GPF 4242 01 100	27	GPF 4670 09 310	32	GPF 4930 09 00C	34
GPF 4050 01 100	22	GPF 4243 01 100	27	GPF 4675 09 310	32	GPF 4931 09 00A	34
		GPF 4245 01 100	27	GPF 4677 09 310	32	GPF 4931 09 00B	34

GPF 4931 09 00C	34	GPF 5031 09 781	82	GPF 5214 09 000	83	GPF 9008 09 042	59
GPF 4935 09 00A	34	GPF 5032 09 781	82	GPF 5215 09 000	83	GPF 9008 09 062	59
GPF 4935 09 00B	34	GPF 5033 09 781	82	GPF 5500 09 020	80	GPF 9012 09 000	58
GPF 4935 09 00C	34	GPF 5034 09 781	82	GPF 5500 09 025	80	GPF 9012 09 032	58
GPF 4936 09 00A	34	GPF 5035 09 781	82	GPF 5500 09 030	80	GPF 9012 09 042	58
GPF 4936 09 00B	34	GPF 5036 09 781	82	GPF 5505 09 020	80	GPF 9012 09 052	58
GPF 4936 09 00C	34	GPF 5037 09 781	82	GPF 5505 09 025	80	GPF 9012 09 062	58
GPF 4940 09 00A	34	GPF 5040 09 782	82	GPF 5505 09 030	80	GPF 9018 09 032	59
GPF 4940 09 00B	34	GPF 5041 09 782	82	GPF 5505 09 035	80	GPF 9018 09 042	59
GPF 4940 09 00C	34	GPF 5050 09 783	82	GPF 5510 09 020	80	GPF 9018 09 062	59
GPF 4941 09 00A	34	GPF 5051 09 783	82	GPF 5510 09 025	80	GPF 9028 09 042	59
GPF 4941 09 00B	34	GPF 5052 09 783	82	GPF 5510 09 030	80	GPF 9028 09 062	59
GPF 4941 09 00C	34	GPF 5060 09 784	83	GPF 5510 09 035	80	GPF 9038 09 042	59
GPF 4942 09 00A	34	GPF 5070 09 784	83	GPF 5515 09 020	80	GPF 9038 09 062	59
GPF 4942 09 00B	34	GPF 5071 09 784	83	GPF 5515 09 025	80	GPF 9042 09 042	58
GPF 4942 09 00C	34	GPF 5072 09 784	83	GPF 5515 09 030	80	GPF 9052 09 042	58
GPF 4943 09 00A	34	GPF 5073 09 784	83	GPF 5515 09 035	80	GPF 9102 09 000	60
GPF 4943 09 00B	34	GPF 5074 09 784	83	GPF 5520 09 020	80	GPF 9102 09 032	60
GPF 4943 09 00C	34	GPF 5080 09 786	83	GPF 5520 09 025	80	GPF 9102 09 042	60
GPF 4945 09 00A	34	GPF 5081 09 786	83	GPF 5520 09 030	80	GPF 9102 09 052	60
GPF 4945 09 00B	34	GPF 5082 09 786	83	GPF 5520 09 035	80	GPF 9102 09 062	60
GPF 4945 09 00C	34	GPF 5083 09 786	83	GPF 5525 09 020	80	GPF 9103 09 000	60
GPF 4946 09 00A	34	GPF 5084 09 786	83	GPF 5525 09 025	80	GPF 9103 09 032	60
GPF 4946 09 00B	34	GPF 5085 09 786	83	GPF 5525 09 030	80	GPF 9103 09 042	60
GPF 4946 09 00C	34	GPF 5086 09 786	83	GPF 5530 09 020	80	GPF 9103 09 052	60
GPF 4948 09 00A	34	GPF 5090 09 787	82	GPF 5530 09 025	80	GPF 9103 09 062	60
GPF 4948 09 00B	34	GPF 5091 09 787	82	GPF 5530 09 030	80	GPF 9112 09 000	60
GPF 4948 09 00C	34	GPF 5092 09 787	82	GPF 5535 09 020	80	GPF 9112 09 032	60
GPF 4949 09 00A	34	GPF 5093 09 787	82	GPF 5535 09 025	80	GPF 9112 09 042	60
GPF 4949 09 00B	34	GPF 5094 09 787	82	GPF 5535 09 030	80	GPF 9112 09 052	60
GPF 4949 09 00C	34	GPF 5095 09 787	82	GPF 5540 09 020	80	GPF 9112 09 062	60
GPF 4951 09 00A	34	GPF 5096 09 787	82	GPF 5540 09 025	80	GPF 9113 09 000	60
GPF 4951 09 00B	34	GPF 5100 09 000	83	GPF 5540 09 030	80	GPF 9113 09 042	60
GPF 4951 09 00C	34	GPF 5101 09 000	83	GPF 5545 09 020	81	GPF 9113 09 062	60
GPF 4952 09 00A	34	GPF 5102 09 000	83	GPF 5545 09 025	81	GPF 9128 09 000	61
GPF 4952 09 00B	34	GPF 5103 09 000	83	GPF 5545 09 030	81	GPF 9128 09 042	61
GPF 4952 09 00C	34	GPF 5104 09 000	83	GPF 5550 09 020	81	GPF 9128 09 062	61
GPF 5000 09 780	82	GPF 5105 09 000	83	GPF 5550 09 025	81	GPF 9138 09 000	61
GPF 5001 09 780	82	GPF 5110 09 000	83	GPF 5550 09 030	81	GPF 9138 09 042	61
GPF 5002 09 780	82	GPF 5150 09 000	83	GPF 5550 09 035	81	GPF 9138 09 062	61
GPF 5003 09 780	82	GPF 5151 09 000	83	GPF 5555 09 020	81	GPF 9142 09 042	60
GPF 5004 09 780	82	GPF 5152 09 000	83	GPF 5555 09 025	81	GPF 9152 09 042	60
GPF 5009 09 781	82	GPF 5153 09 000	83	GPF 5555/ 5560	81	GPF 9202 09 400	63
GPF 5010 09 781	82	GPF 5155 09 000	83	GPF 5560 09 030	81	GPF 9202 09 410	63
GPF 5011 09 781	82	GPF 5200 09 000	83	GPF 5560 09 035	81	GPF 9204 09 400	63
GPF 5012 09 781	82	GPF 5201 09 000	83	GPF 5565 09 035	81	GPF 9204 09 410	63
GPF 5013 09 781	82	GPF 5202 09 000	83	GPF 5565 09 040	81	GPF 9206 09 400	63
GPF 5022 09 781	82	GPF 5203 09 000	83	GPF 5565 09 045	81	GPF 9206 09 410	63
GPF 5023 09 781	82	GPF 5204 09 000	83	GPF 9002 09 000	58	GPF 9208 09 400	63
GPF 5025 09 781	82	GPF 5205 09 000	83	GPF 9002 09 032	58	GPF 9208 09 410	63
GPF 5026 09 781	82	GPF 5210 09 000	83	GPF 9002 09 042	58	GPF 9250 09 099	48
GPF 5027 09 781	82	GPF 5211 09 000	83	GPF 9002 09 052	58	GPF 9250 09 099	49
GPF 5029 09 781	82	GPF 5212 09 000	83	GPF 9002 09 062	58	GPF 9250 49 099	49
GPF 5030 09 781	82	GPF 5213 09 000	83	GPF 9008 09 032	59	GPF 9252 09 099	48

GPF 9252 49 099	49	GPF 9351 09 642	51	GPF 9670 09 716	75	GPF 9802 09 000	68
GPF 9280 09 199	66	GPF 9352 09 042	55	GPF 9670 K2 715	75	GPF 9803 09 000	68
GPF 9280 49 199	66	GPF 9385 09 199	65	GPF 9670 K3 715	75	GPF 9804 09 000	68
GPF 9282 09 199	66	GPF 9390 09 199	65	GPF 9671 09 716	75	GPF 9805 09 000	68
GPF 9282 49 199	66	GPF 9390 49 199	65	GPF 9671 K2 715	75	GPF 9806 09 000	68
GPF 9284 09 199	66	GPF 9400 09 000	90	GPF 9671 K3 715	75	GPF 9807 09 000	68
GPF 9284 49 199	66	GPF 9405 09 000	90	GPF 9672 09 716	75	GPF 9808 09 000	68
GPF 9286 09 199	66	GPF 9410 09 000	90	GPF 9672 K2 715	75	GPF 9809 09 000	68
GPF 9286 49 199	66	GPF 9415 09 000	90	GPF 9672 K3 715	75	GPF 9810 09 000	68
GPF 9288 09 199	66	GPF 9425 09 000	90	GPF 9673 09 716	75	GPF 9811 09 000	68
GPF 9288 49 199	66	GPF 9440 09 000	90	GPF 9673 K2 715	75	GPF 9812 09 000	68
GPF 9292 09 199	66	GPF 9450 09 000	91	GPF 9673 K3 715	75	GPF 9813 09 000	68
GPF 9307 09 532	52	GPF 9462 09 000	91	GPF 9674 09 716	75	GPF 9814 09 199	67
GPF 9307 09 542	52	GPF 9480 09 000	91	GPF 9674 K4 715	75	GPF 9814 49 199	67
GPF 9307 09 562	52	GPF 9490 09 000	91	GPF 9675 09 716	75	GPF 9815 09 199	65
GPF 9307 09 632	52	GPF 9495 09 000	91	GPF 9675 K4 715	75	GPF 9815 49 199	65
GPF 9307 09 642	52	GPF 9497 09 701	73	GPF 9676 09 716	75	GPF 9816 09 199	65
GPF 9307 09 662	52	GPF 9498 09 701	73	GPF 9676 K4 715	75	GPF 9816 49 199	65
GPF 9308 09 032	54	GPF 9499 09 701	73	GPF 9677 09 716	75	GPF 9819 09 199	67
GPF 9308 09 042	54	GPF 9500 09 701	73	GPF 9677 K4 715	75	GPF 9819 49 199	67
GPF 9308 09 062	54	GPF 9505 09 701	73	GPF 9678 09 716	75	GPF 9820 09 199	65
GPF 9311 09 032	50	GPF 9506 09 701	73	GPF 9678 K4 715	75	GPF 9820 49 199	65
GPF 9311 09 042	50	GPF 9510 09 701	73	GPF 9679 09 716	75	GPF 9821 09 199	65
GPF 9311 09 052	50	GPF 9520 09 701	73	GPF 9679 K4 715	75	GPF 9821 49 199	65
GPF 9311 09 062	50	GPF 9525 09 701	73	GPF 9680 09 717	76	GPF 9822 09 400	67
GPF 9312 09 032	54	GPF 9528 09 701	73	GPF 9681 09 719	76	GPF 9823 09 400	67
GPF 9312 09 042	54	GPF 9530 09 701	73	GPF 9682 09 719	76	GPF 9824 09 400	67
GPF 9312 09 052	54	GPF 9532 09 701	73	GPF 9683 09 719	76	GPF 9825 09 400	67
GPF 9312 09 062	54	GPF 9540 09 702	73	GPF 9685 09 718	76	GPF 9826 02 400	69
GPF 9317 09 532	52	GPF 9555 09 703	73	GPF 9685 K2 720	76	GPF 9826 03 400	69
GPF 9317 09 542	52	GPF 9560 09 703	73	GPF 9685 K3 720	76	GPF 9826 04 400	69
GPF 9317 09 562	52	GPF 9580 09 705	73	GPF 9687 09 719	76	GPF 9826 05 400	69
GPF 9317 09 632	52	GPF 9585 09 705	73	GPF 9689 09 719	76	GPF 9826 06 400	69
GPF 9317 09 642	52	GPF 9590 09 705	73	GPF 9690 09 719	76	GPF 9826 08 400	69
GPF 9317 09 662	52	GPF 9592 09 706	73	GPF 9691 09 719	76	GPF 9826 09 400	69
GPF 9318 09 032	54	GPF 9594 09 706	73	GPF 9692 09 719	76	GPF 9826 40 400	69
GPF 9318 09 042	54	GPF 9596 09 706	73	GPF 9695 09 719	76	GPF 9826 42 400	69
GPF 9318 09 062	54	GPF 9600 09 707	73	GPF 9696 09 719	76	GPF 9826 43 400	69
GPF 9327 09 542	53	GPF 9605 09 707	73	GPF 9697 09 719	76	GPF 9826 45 400	69
GPF 9327 09 562	53	GPF 9620 09 709	74	GPF 9698 09 719	76	GPF 9826 46 400	69
GPF 9327 09 642	53	GPF 9630 09 712	74	GPF 9699 09 721	76	GPF 9826 48 400	69
GPF 9327 09 662	53	GPF 9646 09 716	75	GPF 9700 09 722	77	GPF 9827 02 400	69
GPF 9328 09 042	55	GPF 9647 09 716	75	GPF 9725 09 723	77	GPF 9827 03 400	69
GPF 9328 09 062	55	GPF 9650 09 716	75	GPF 9750 09 770	79	GPF 9827 04 400	69
GPF 9337 09 542	53	GPF 9651 09 716	75	GPF 9755 09 770	79	GPF 9827 05 400	69
GPF 9337 09 562	53	GPF 9654 09 716	75	GPF 9760 09 775	79	GPF 9827 06 400	69
GPF 9337 09 642	53	GPF 9655 09 716	75	GPF 9770 09 725	78	GPF 9827 08 400	69
GPF 9337 09 662	53	GPF 9655 K1 715	75	GPF 9775 09 725	78	GPF 9827 09 400	69
GPF 9338 09 042	55	GPF 9660 09 716	75	GPF 9780 09 730	78	GPF 9827 40 400	69
GPF 9338 09 062	55	GPF 9660 K1 715	75	GPF 9785 09 730	78	GPF 9827 42 400	69
GPF 9341 09 542	51	GPF 9664 09 716	75	GPF 9790 09 735	79	GPF 9827 43 400	69
GPF 9341 09 642	51	GPF 9664 K1 715	75	GPF 9795 09 740	79	GPF 9827 45 400	69
GPF 9342 09 042	55	GPF 9665 09 716	75	GPF 9800 09 000	68	GPF 9827 46 400	69
GPF 9351 09 542	51	GPF 9665 K1 715	75	GPF 9801 09 000	68	GPF 9827 48 400	69



CombiVari[®]
HET FLEXIBELE DEURBESLAG

Volledige *keuzevrijheid* in het *samenstellen* op de display.
Ook als wandpresentatie verkrijgbaar.



- Complete *freedom* in composing your product on the display. Also available as a wall display.
- Völlige *Freiheit* in der Komposition die Türbeschläge auf die display. Auch als Wand erhältlich.
- Une *liberté* totale dans le choix et la combinaison de garnitures présentation. Aussi disponible sur la paroi.

1



2



3



Altijd *en overal* onze brochures bekijken



- View our brochures anywhere, anytime
- Sehen Sie immer und überall unsere Broschüren
- Vu toujours et partout nos brochures

www.tenhulscher.com